

THIN 27_THPW

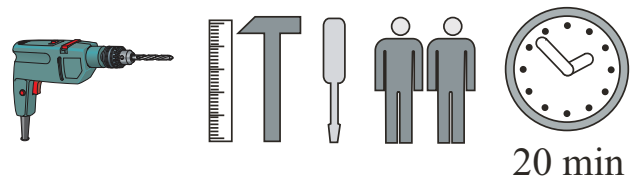

NO	Dim.[mm]			Col.-No	Qty
1	1500	124	16	1	1
2	1496	184	16	1	1

THIN 27_THPW

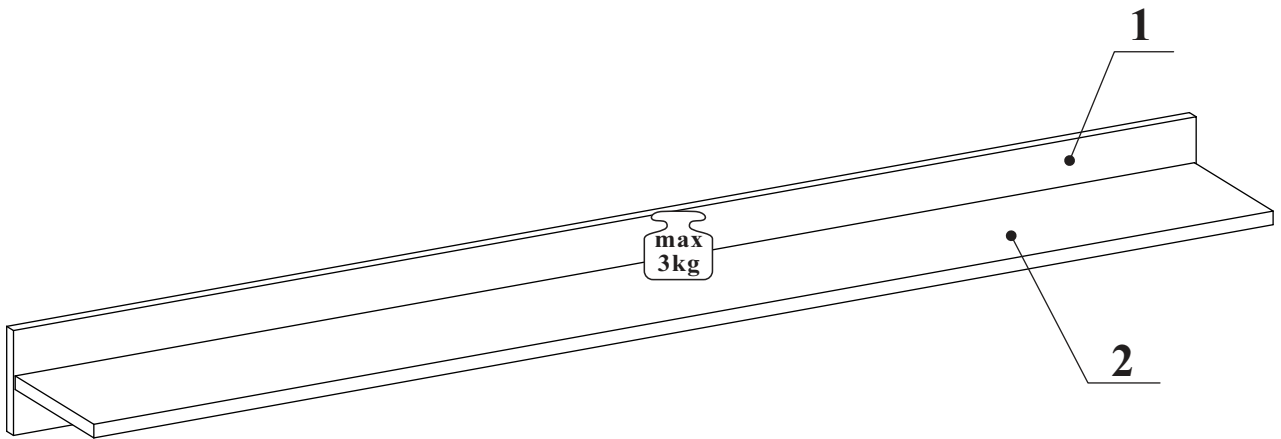
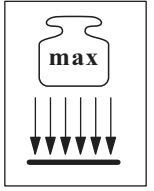
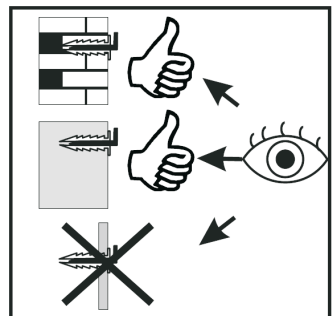
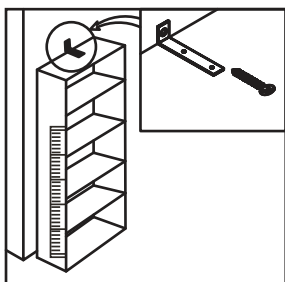
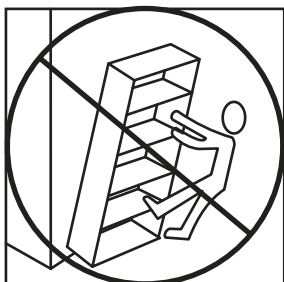
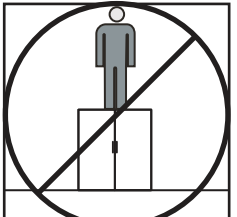
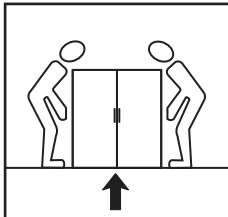
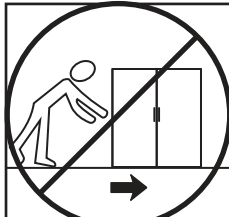
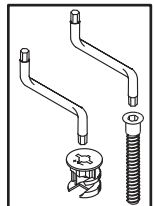
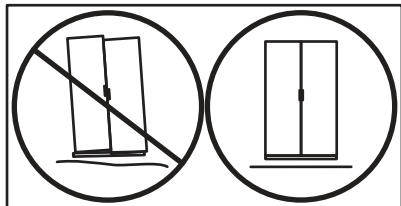
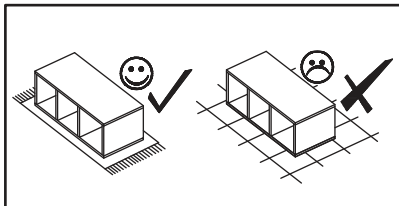
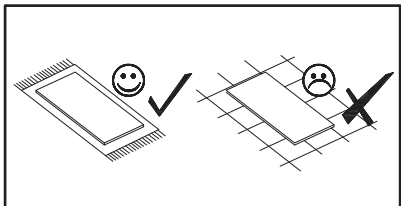
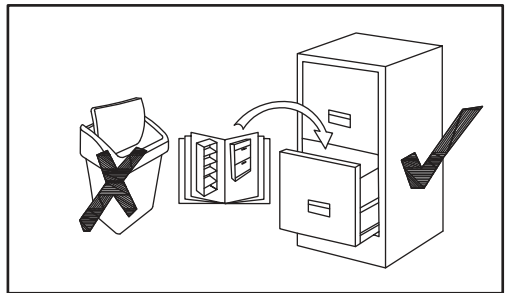
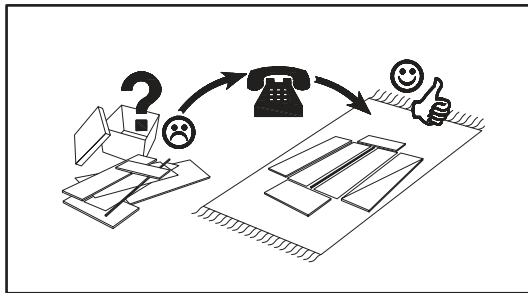
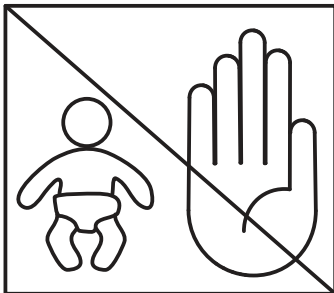
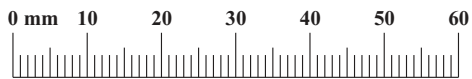
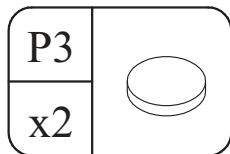
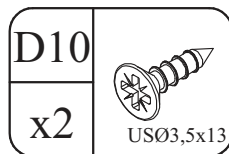
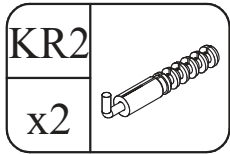
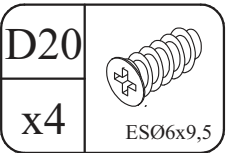
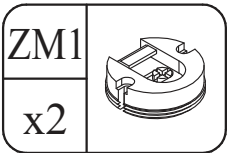
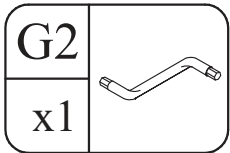
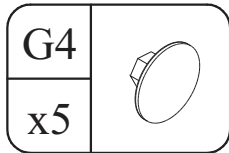
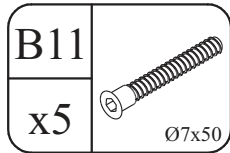

1

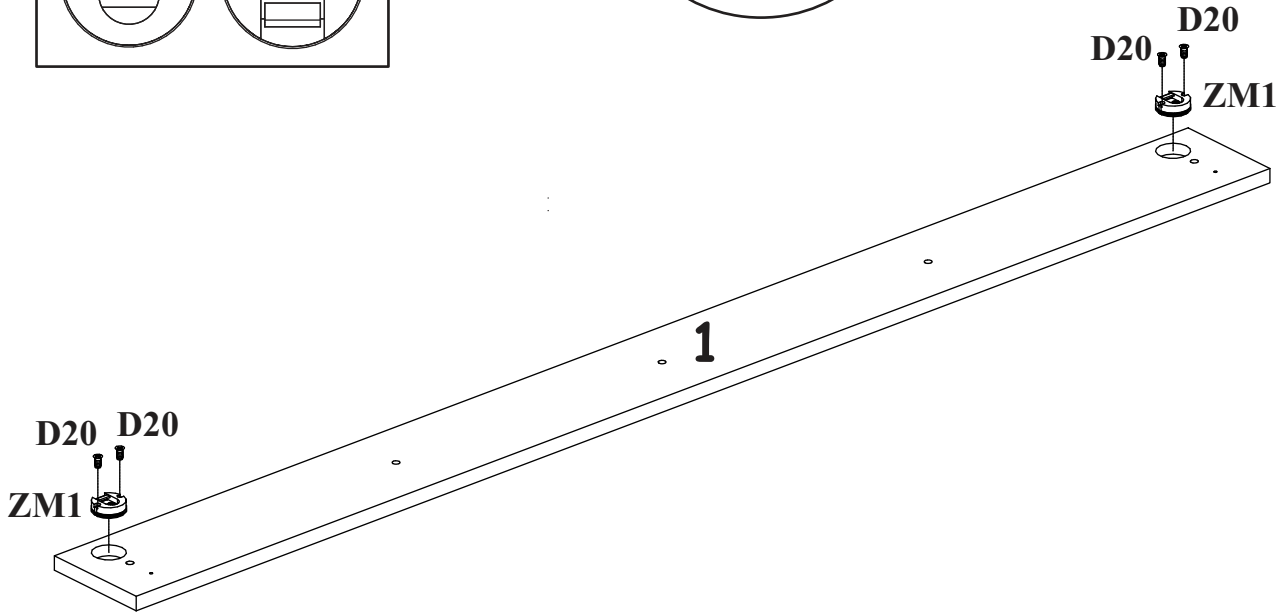
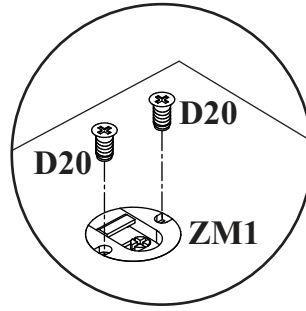
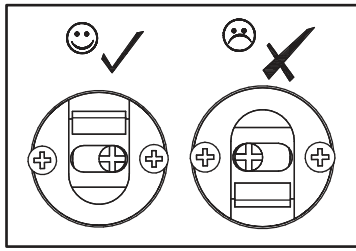

2

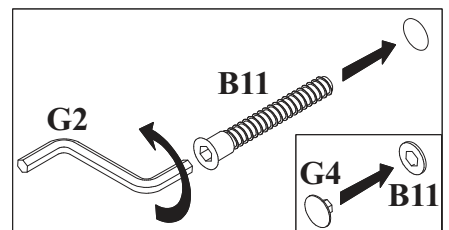
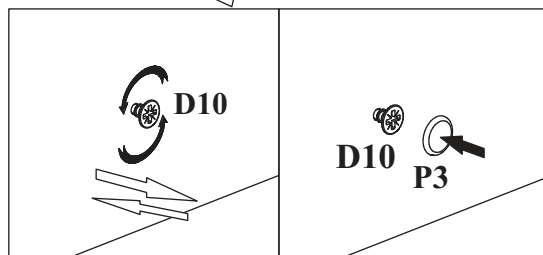
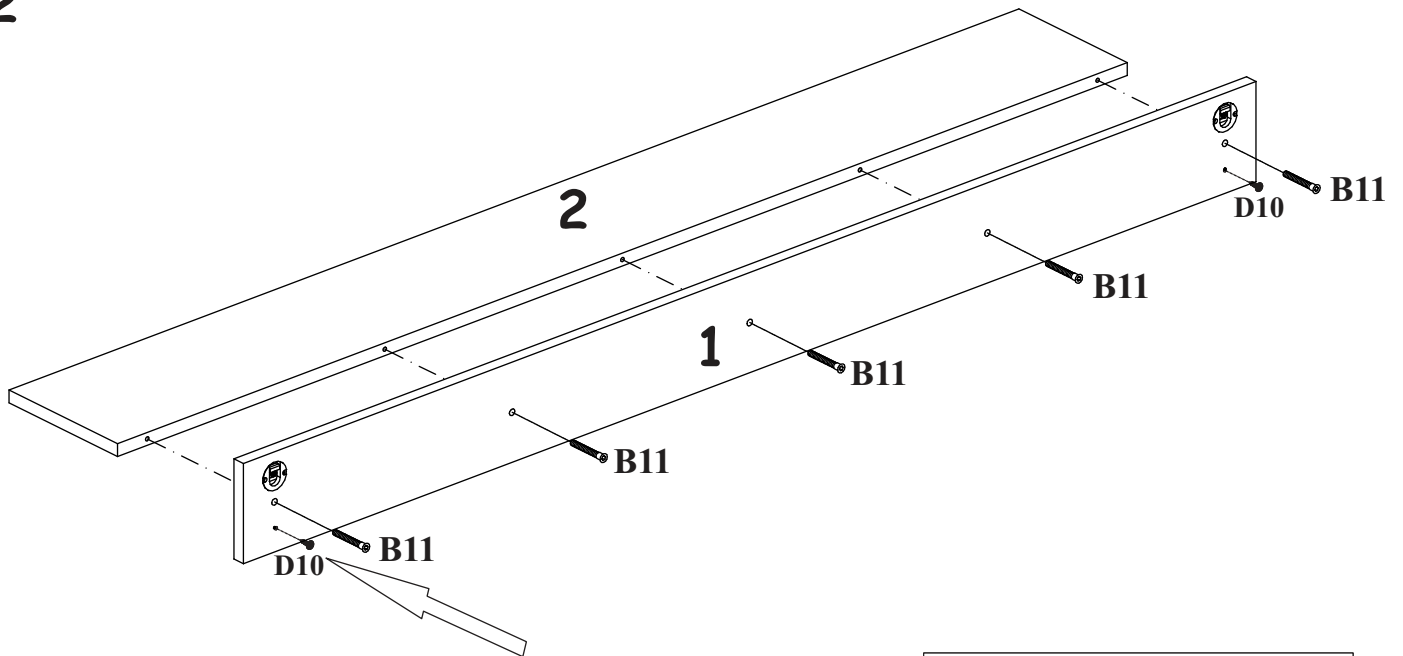

3

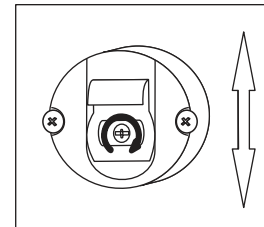
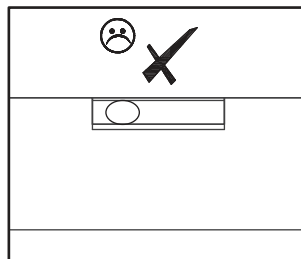
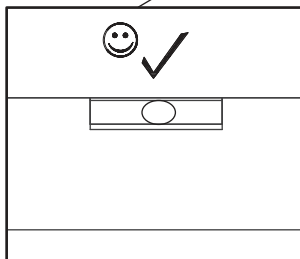
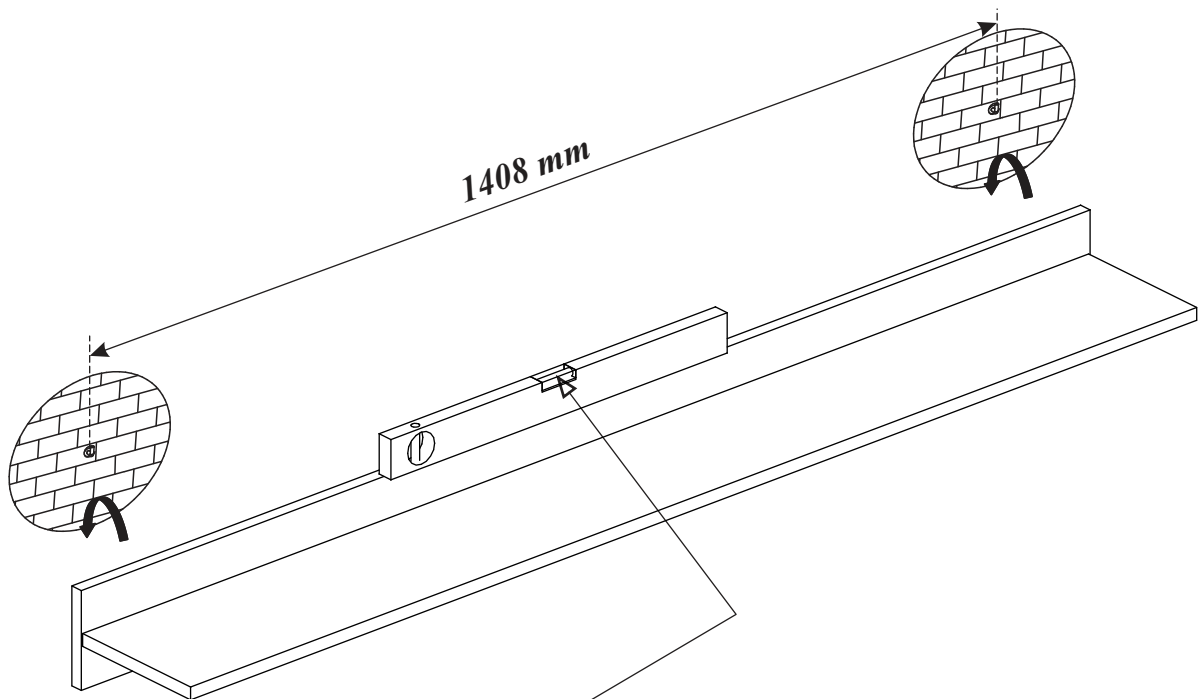
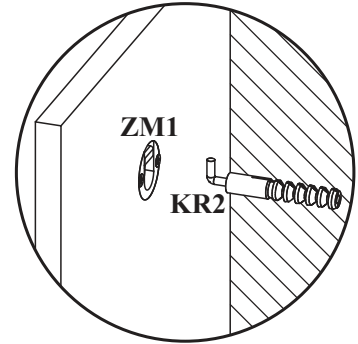
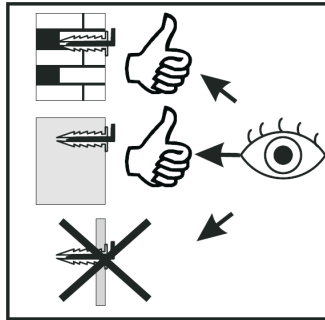
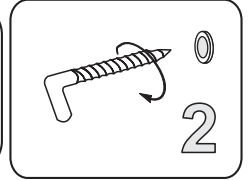
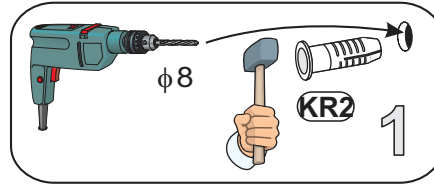

THIN 27_THTHS

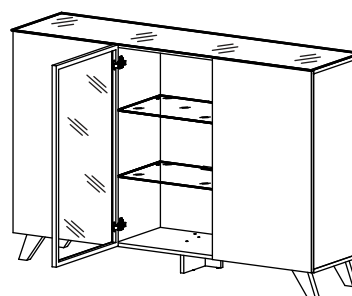
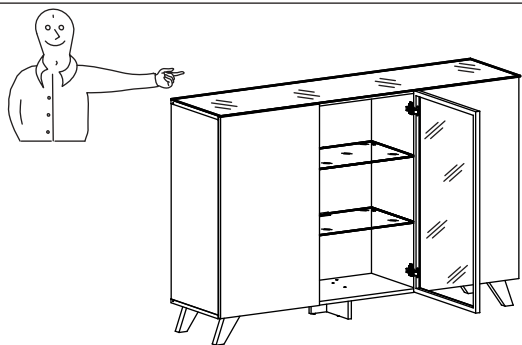
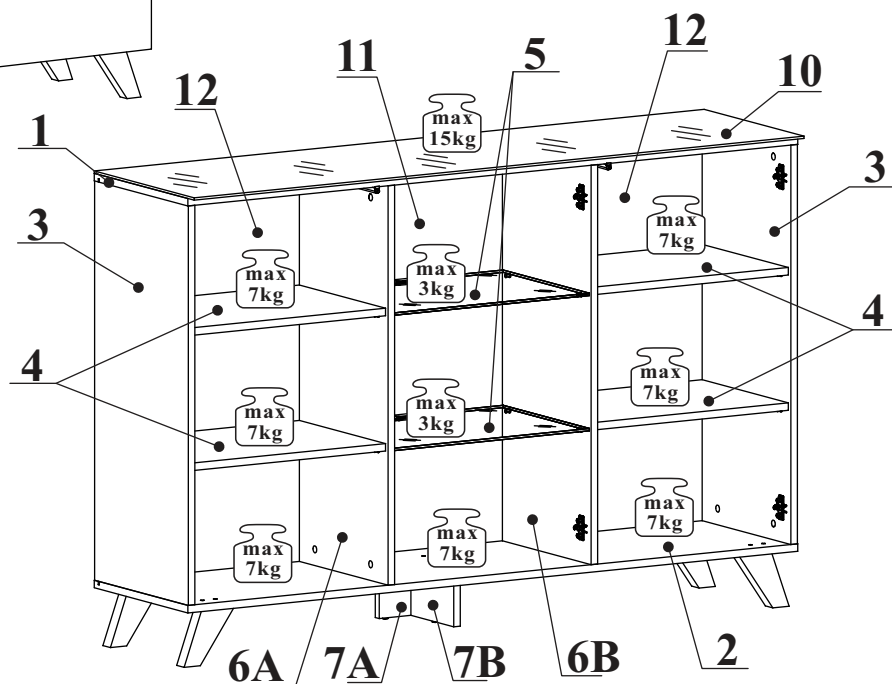
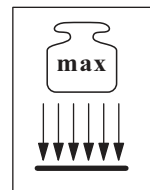
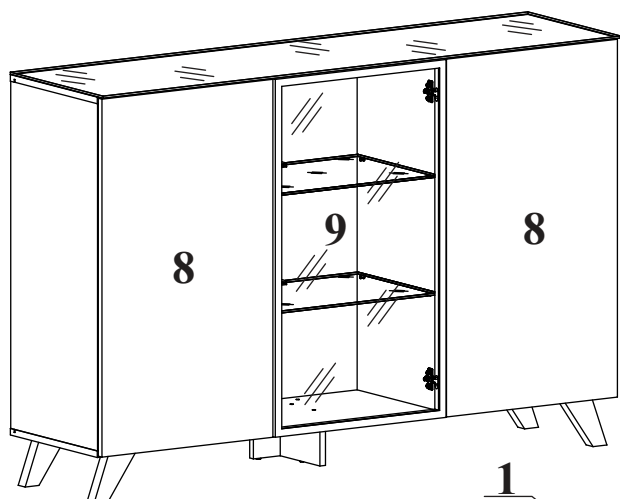



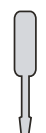





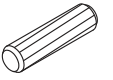
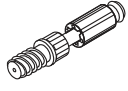

NO	Dim.[mm]			Col.-No	Qty
1	1502	376	16	2	1
2	1502	376	16	2	1
3	850	376	16	1	2
4	476	346	16	2	4
5	483	346	5	1	2
6A / 6B	850	356	16	1	2
7A	115	172	16	2	1
7B	115	172	16	2	1
8	496	876	16	1	2
9	496	876	21	1	1
10	1502	401	5	2	1
11	500	862	3	1	1
12	490	862	3	1	2

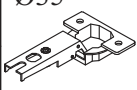
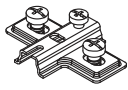
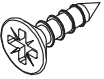
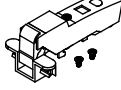
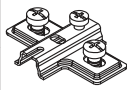

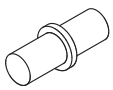
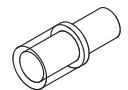
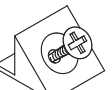
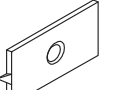
120 min

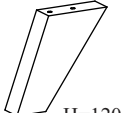
THIN 27_THTHS

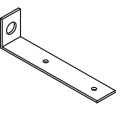
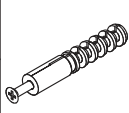
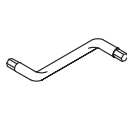
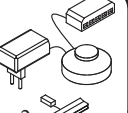
A1 x16  ø8x36	B4 x16 	B5 x16  Ø15x12	G5 x16 	B11 x14  Ø7x50	G4 x14 
E21 x4 Ø35  H=0	E2 x4  H=0	D10 x16  USØ3,5x13	E31 x2  H=8	E4 x2  H=2	Z2 x4  Ø5
G7 x16 	G20 x8 	S1 x18 	G16 x8 	UP13 x8  UPØ3x16	OD1 x3 
SK x4  H=120	I2 x3 	L1 x1 	KR1 x1 	G2 x1 	LED x1  x2

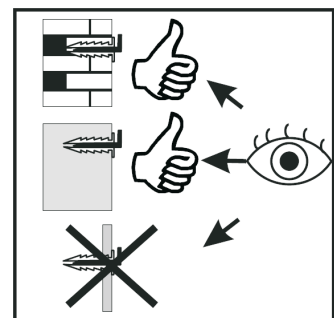
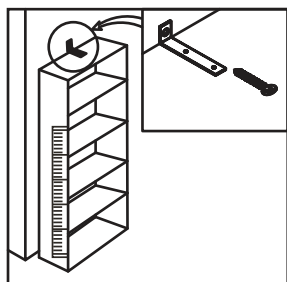
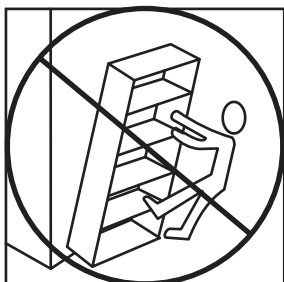
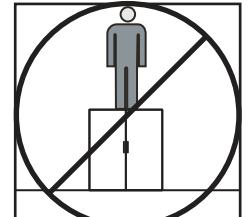
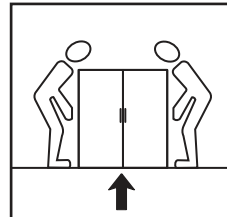
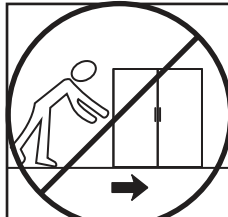
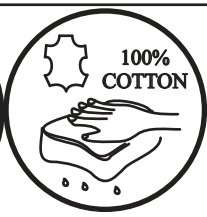
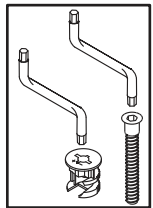
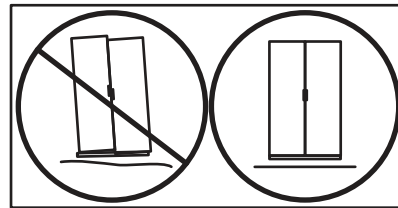
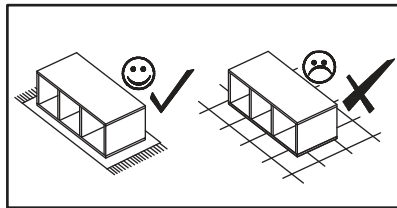
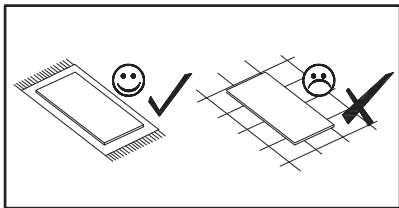
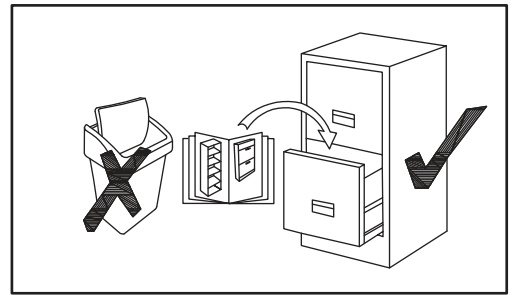
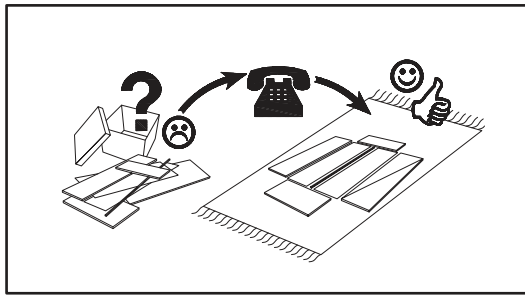
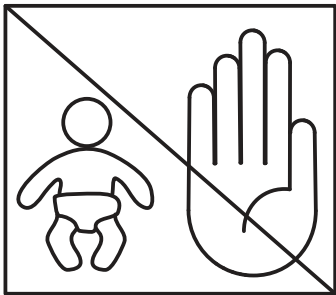
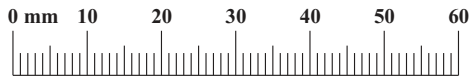

1

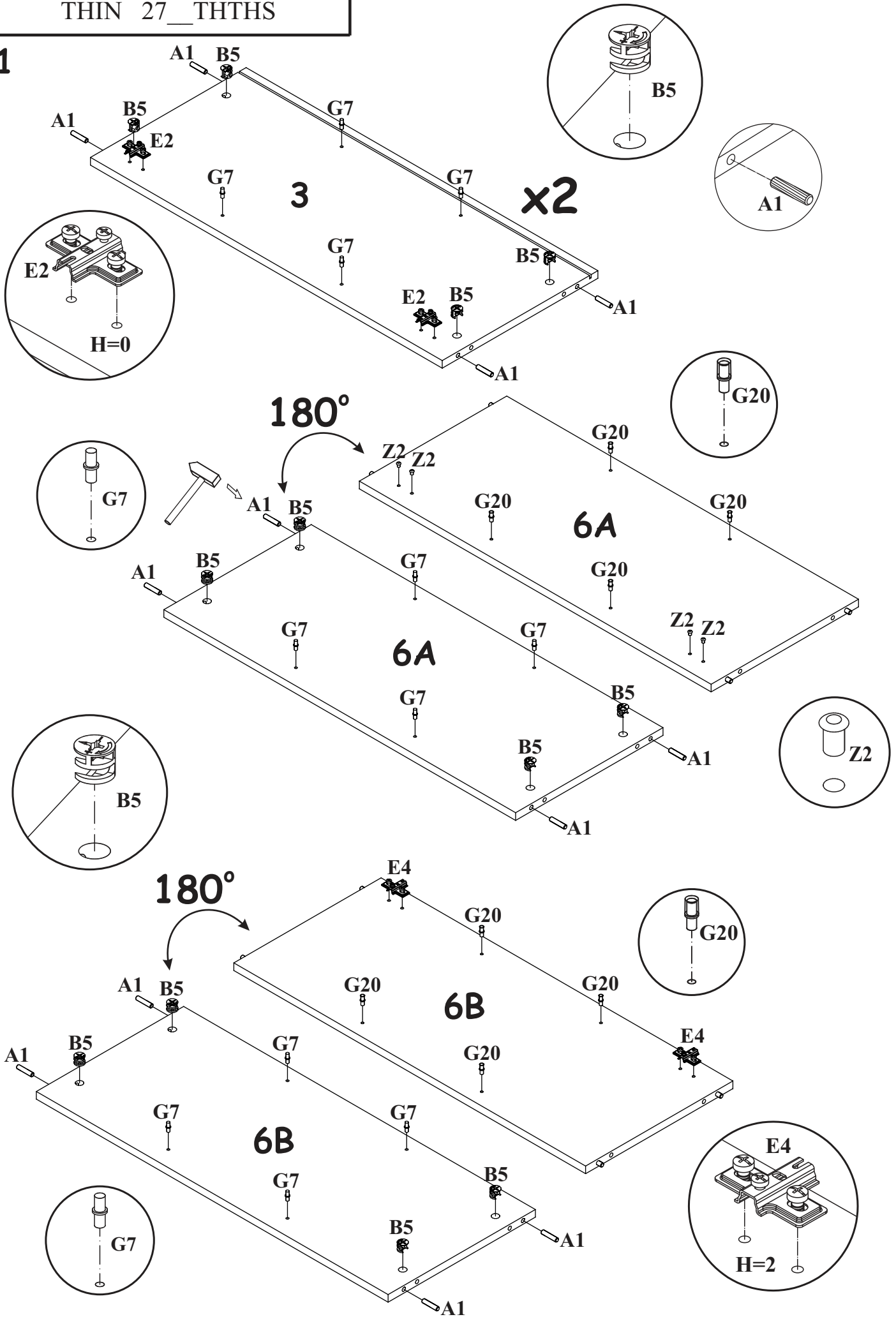

2

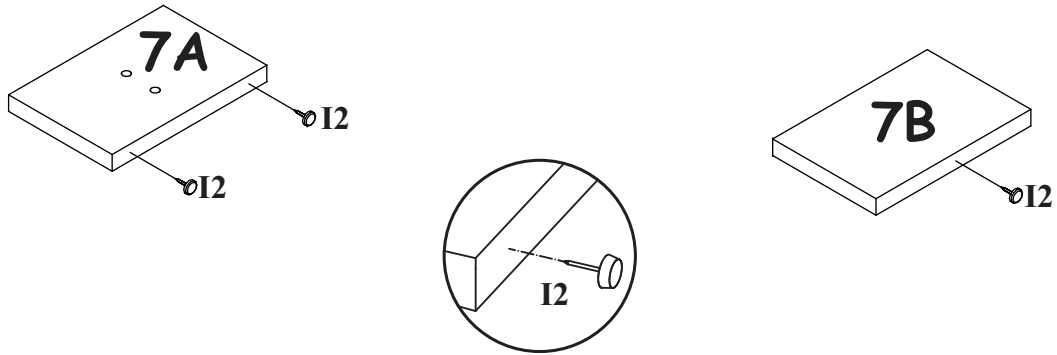

3

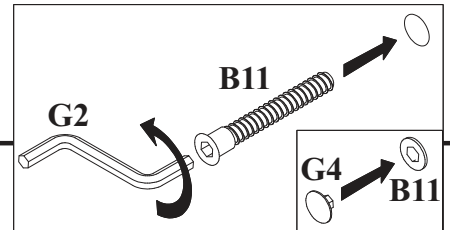
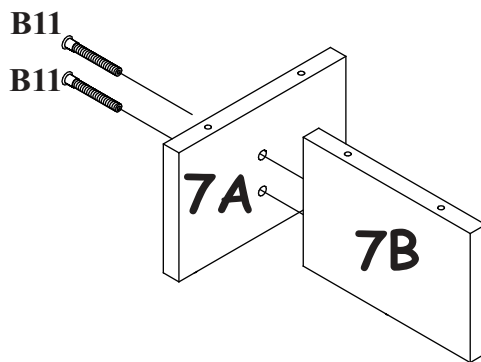

4

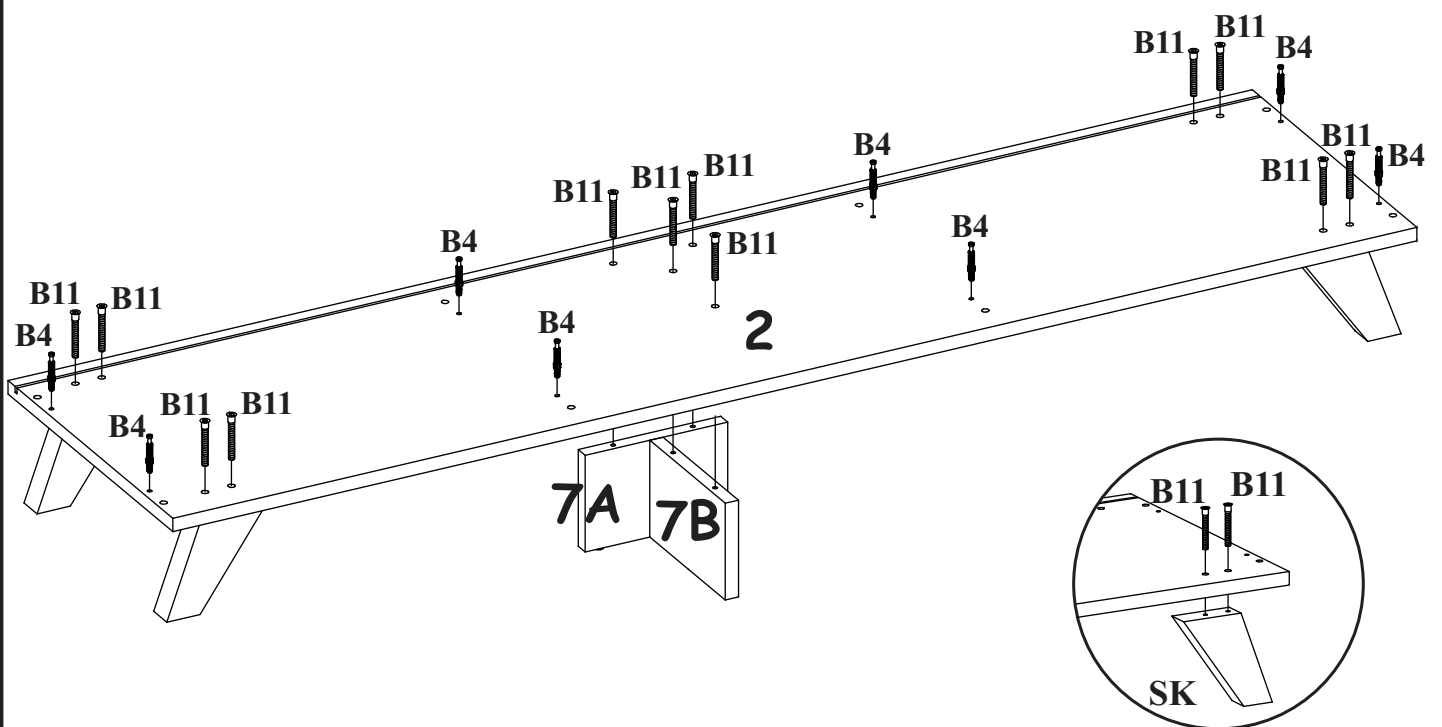

5

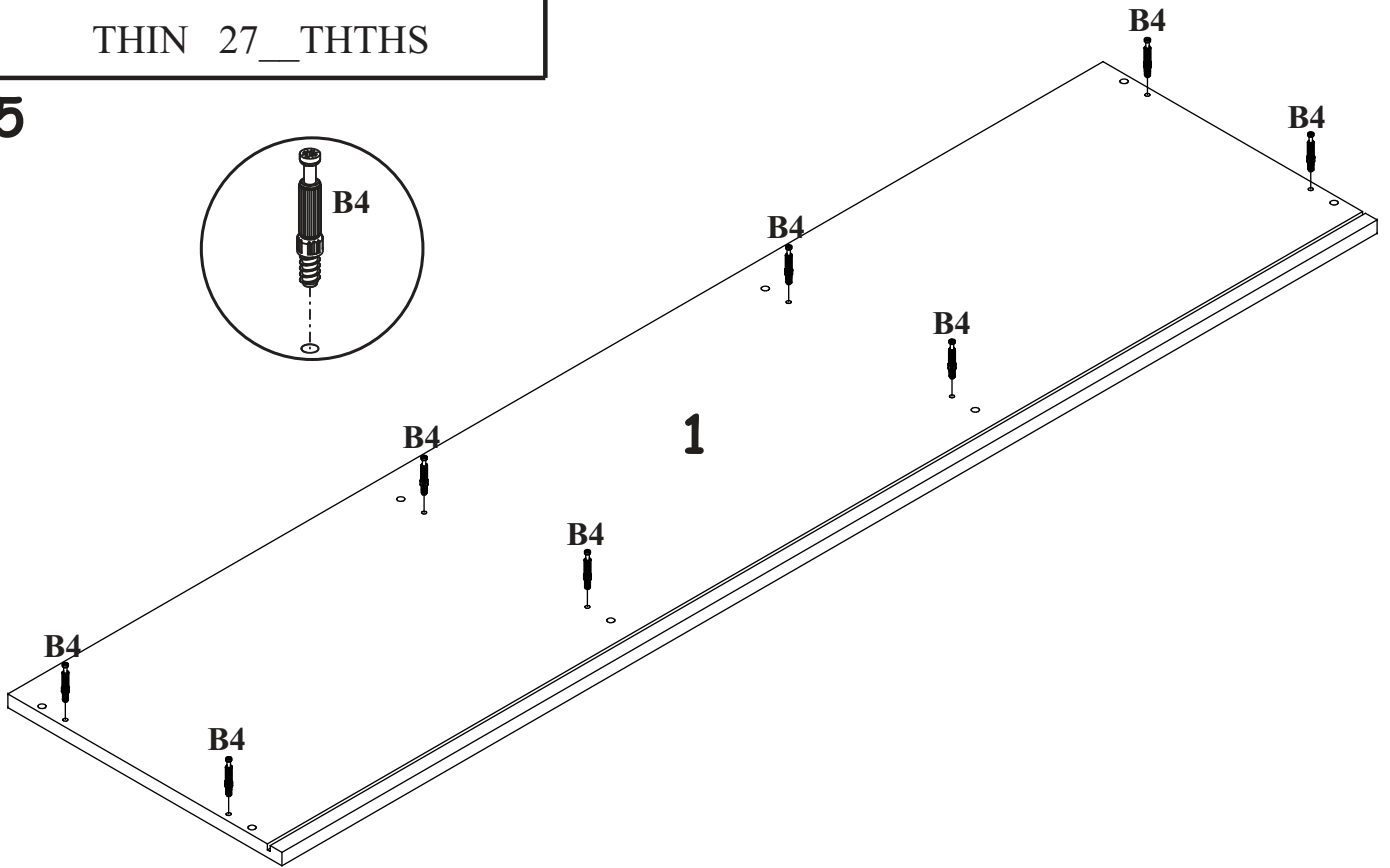

6

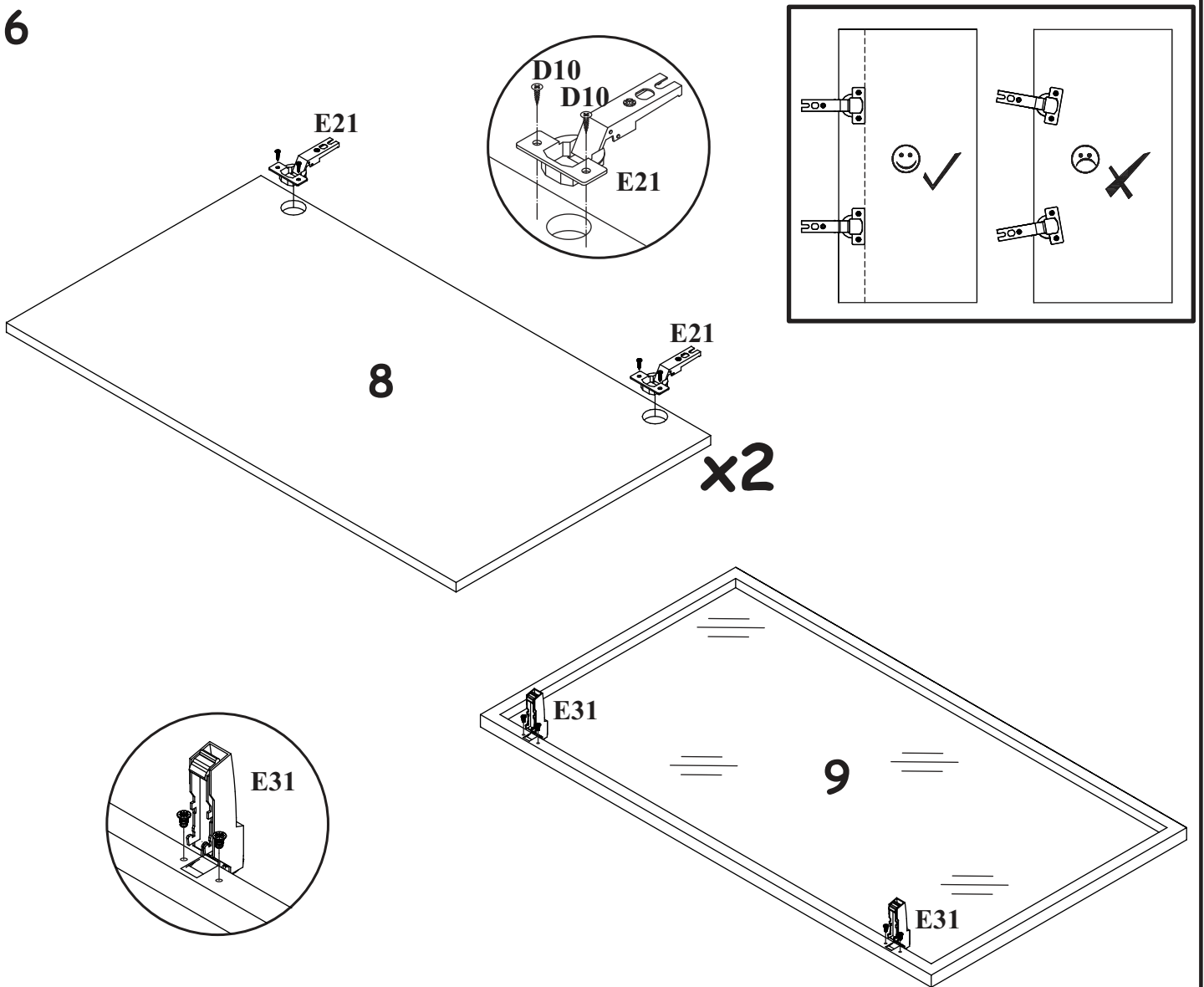

7

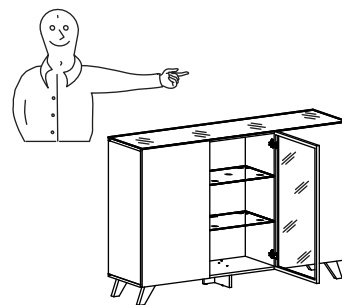
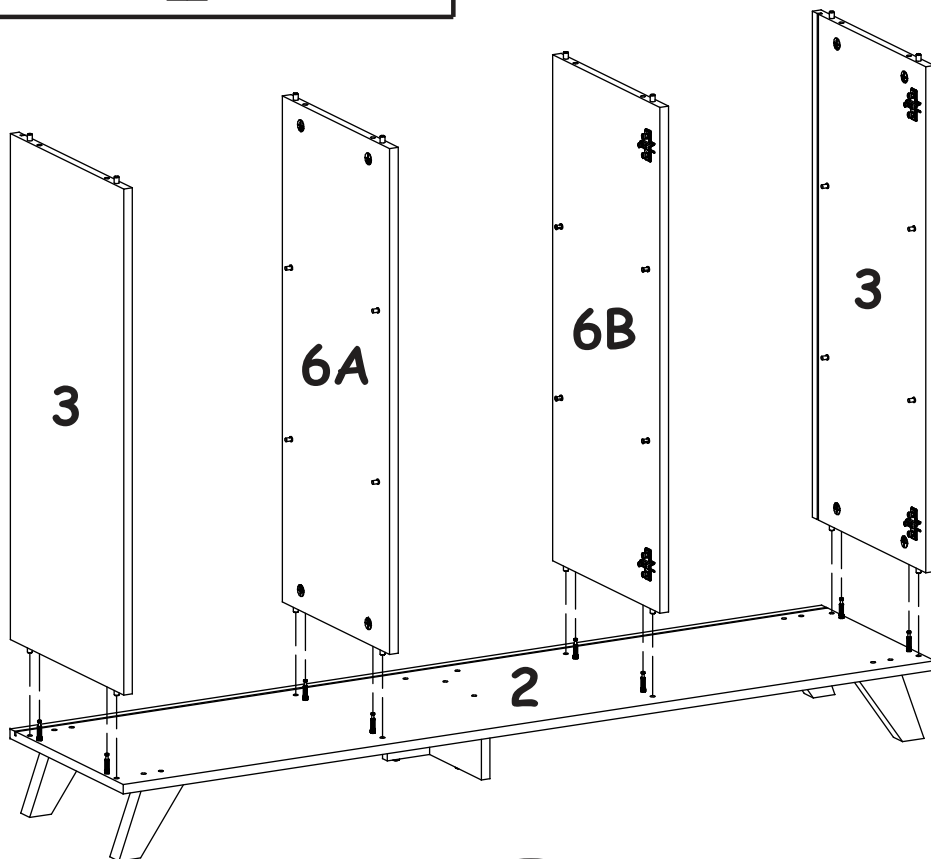

7

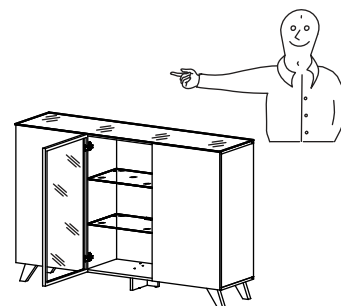
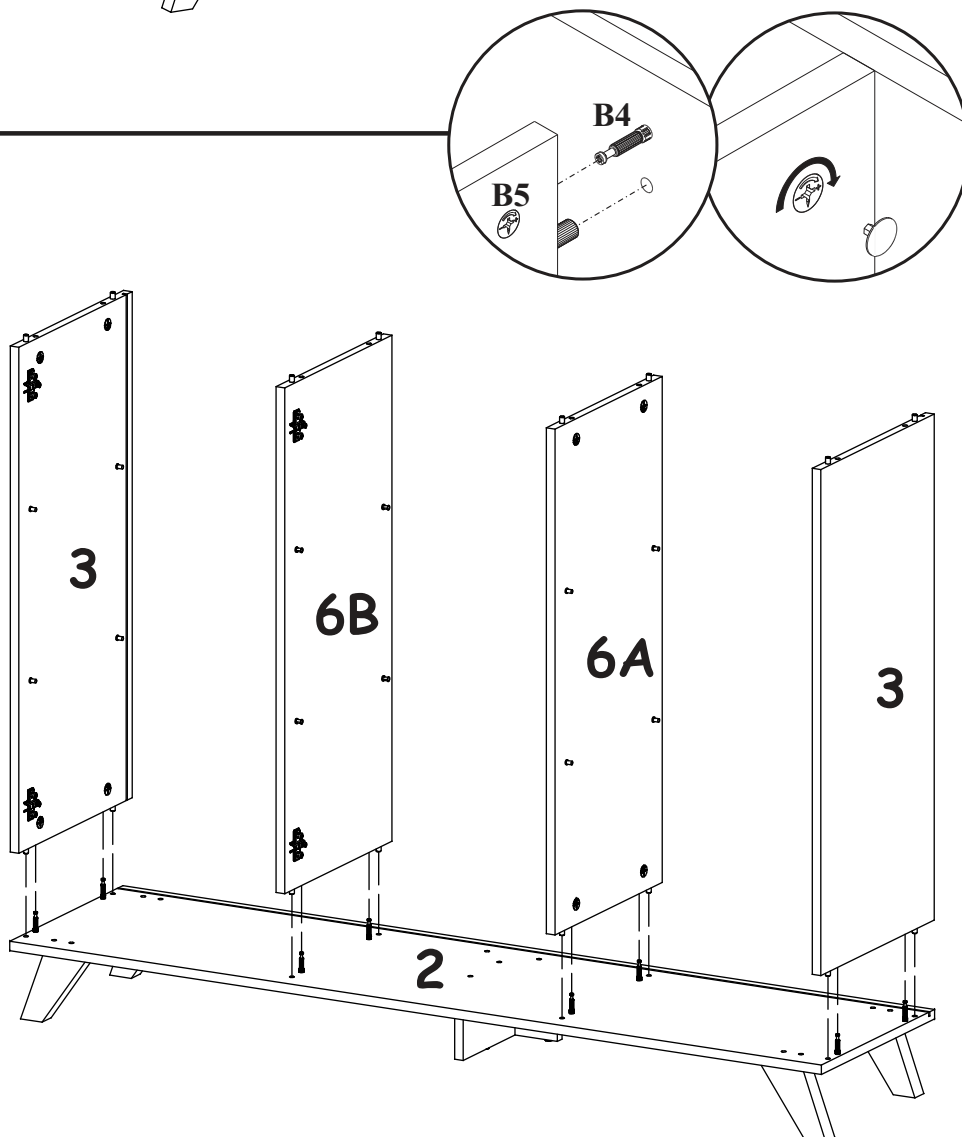

8

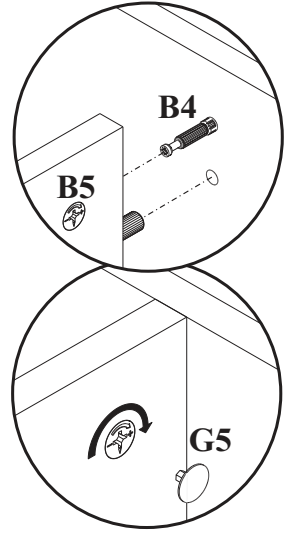
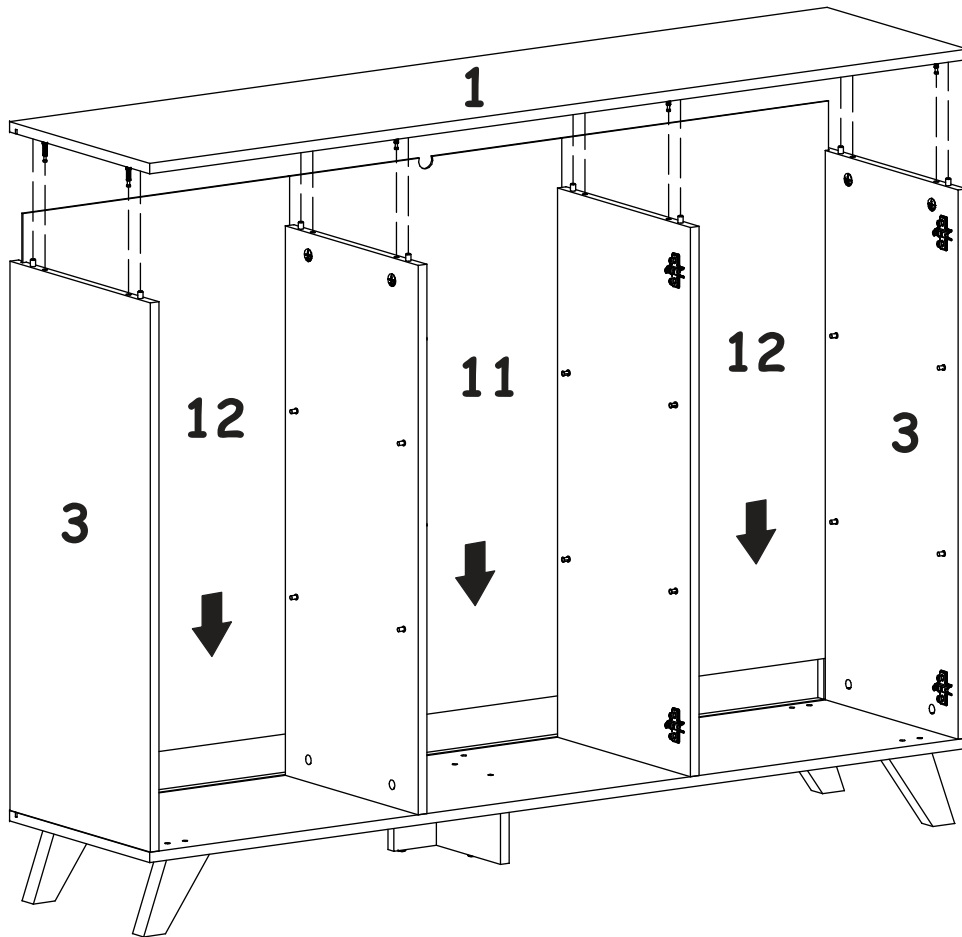

9

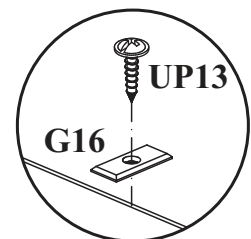
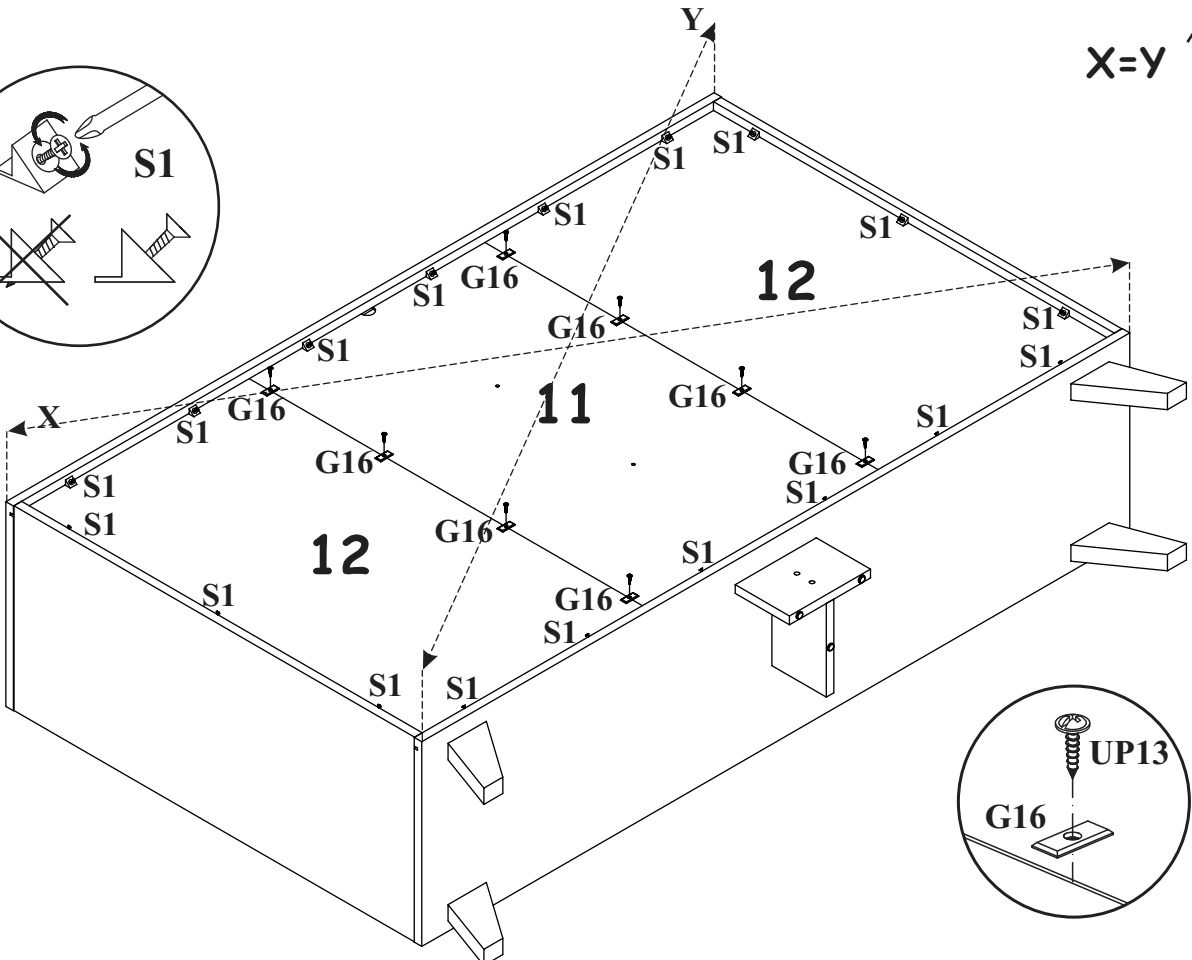
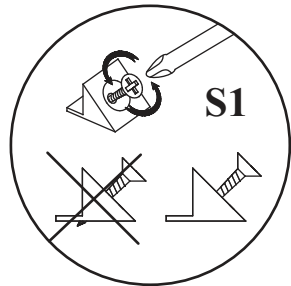

10

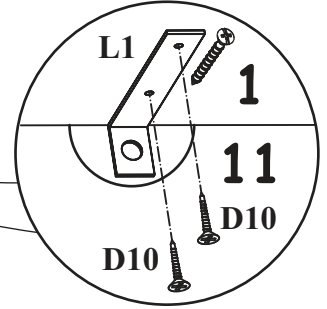
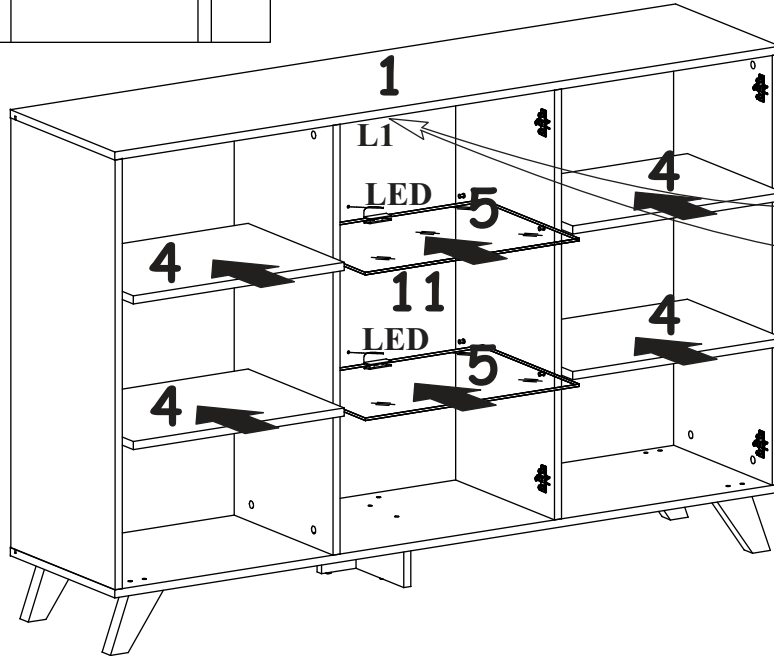
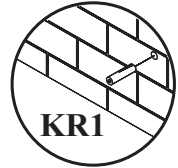
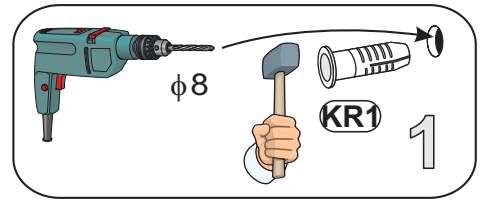
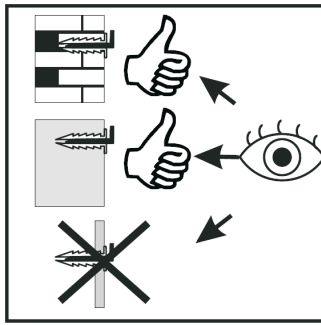
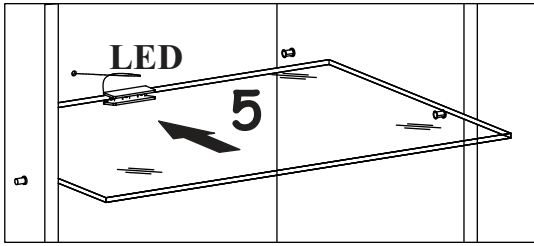

11

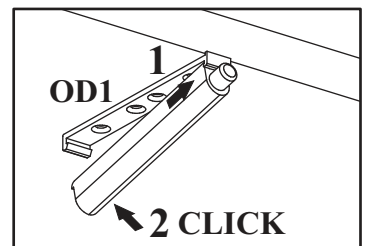
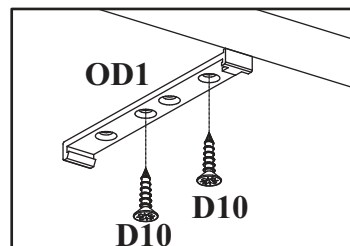
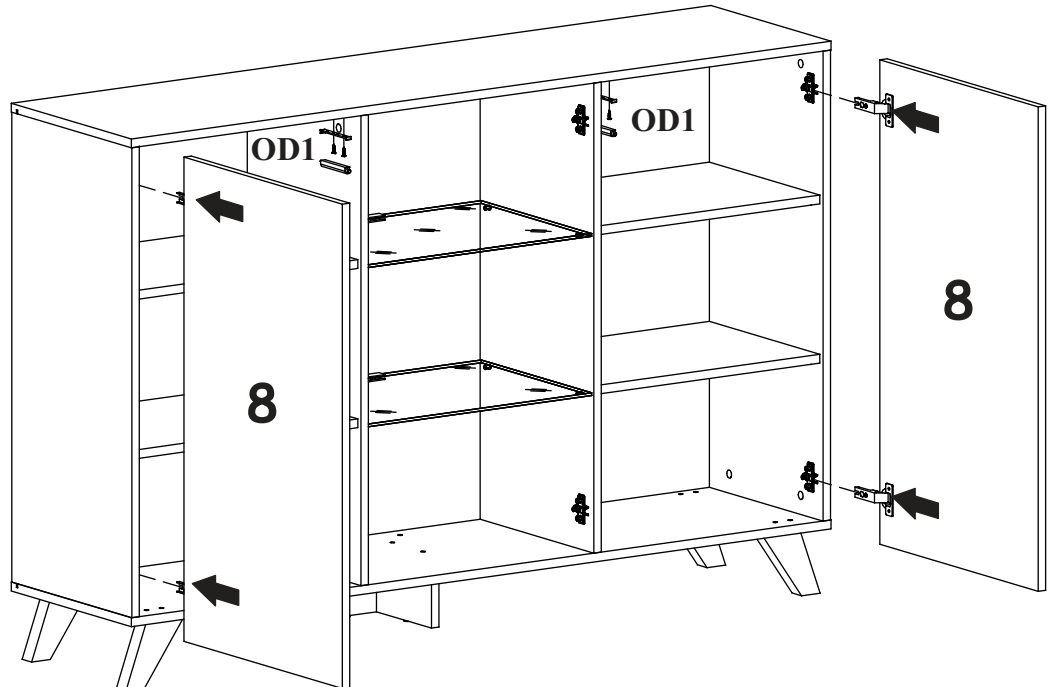
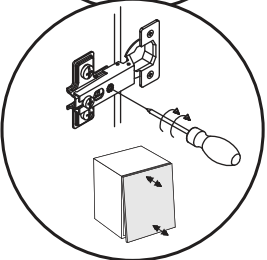
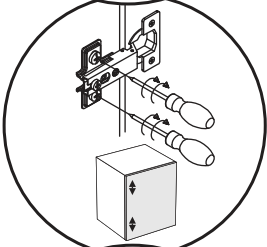
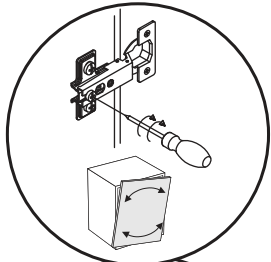

12

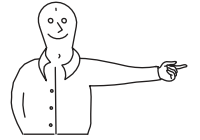
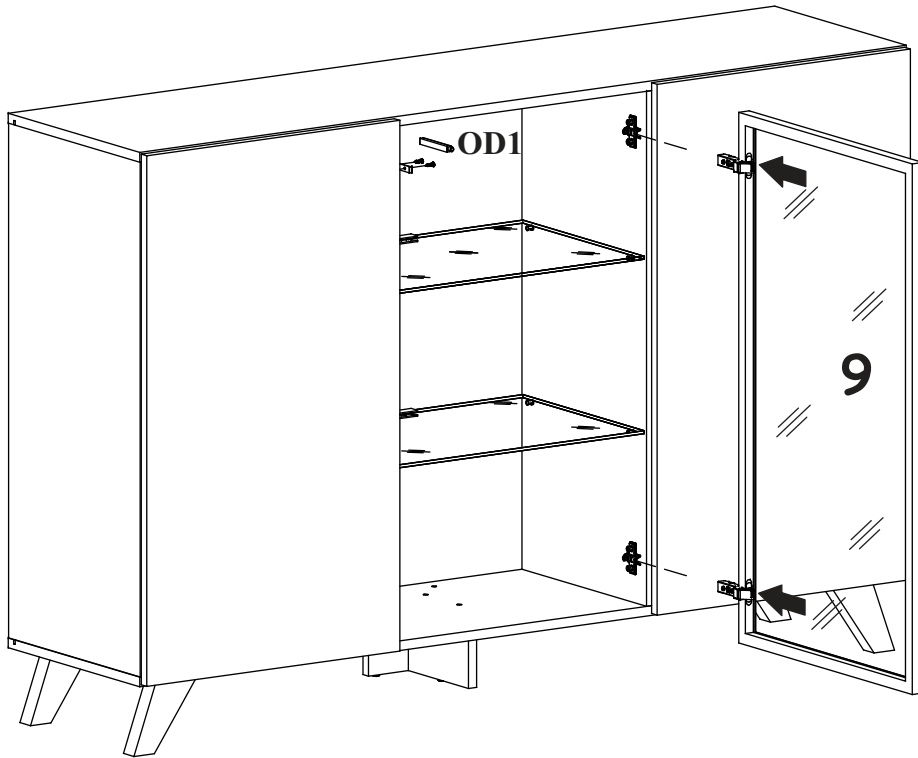

12

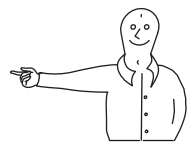
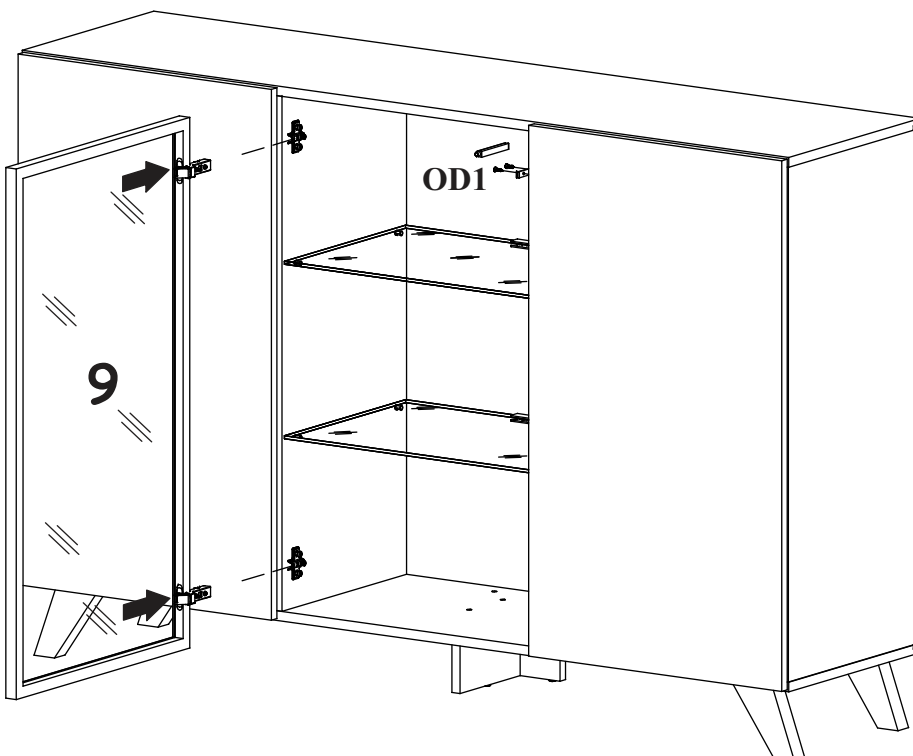
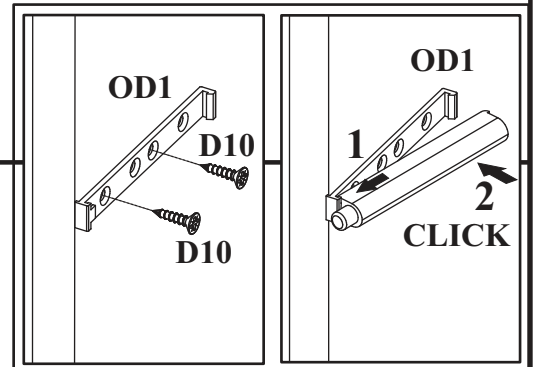
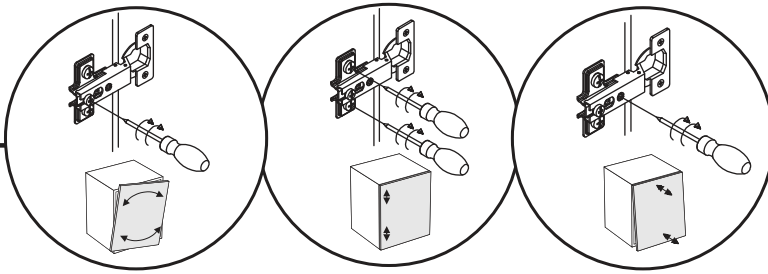

THIN 27_THTHS

13

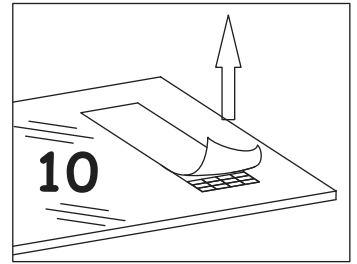
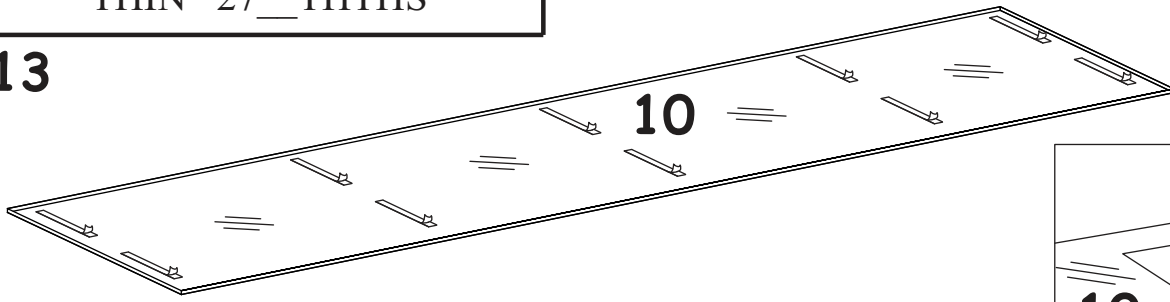

14

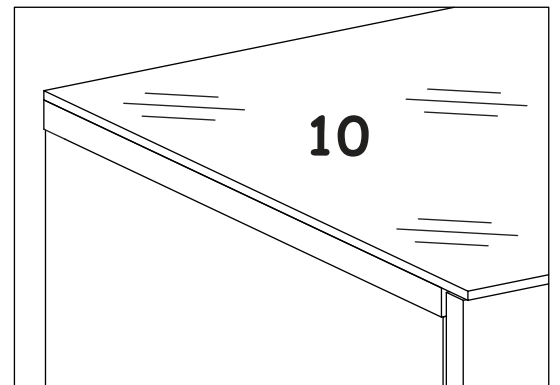
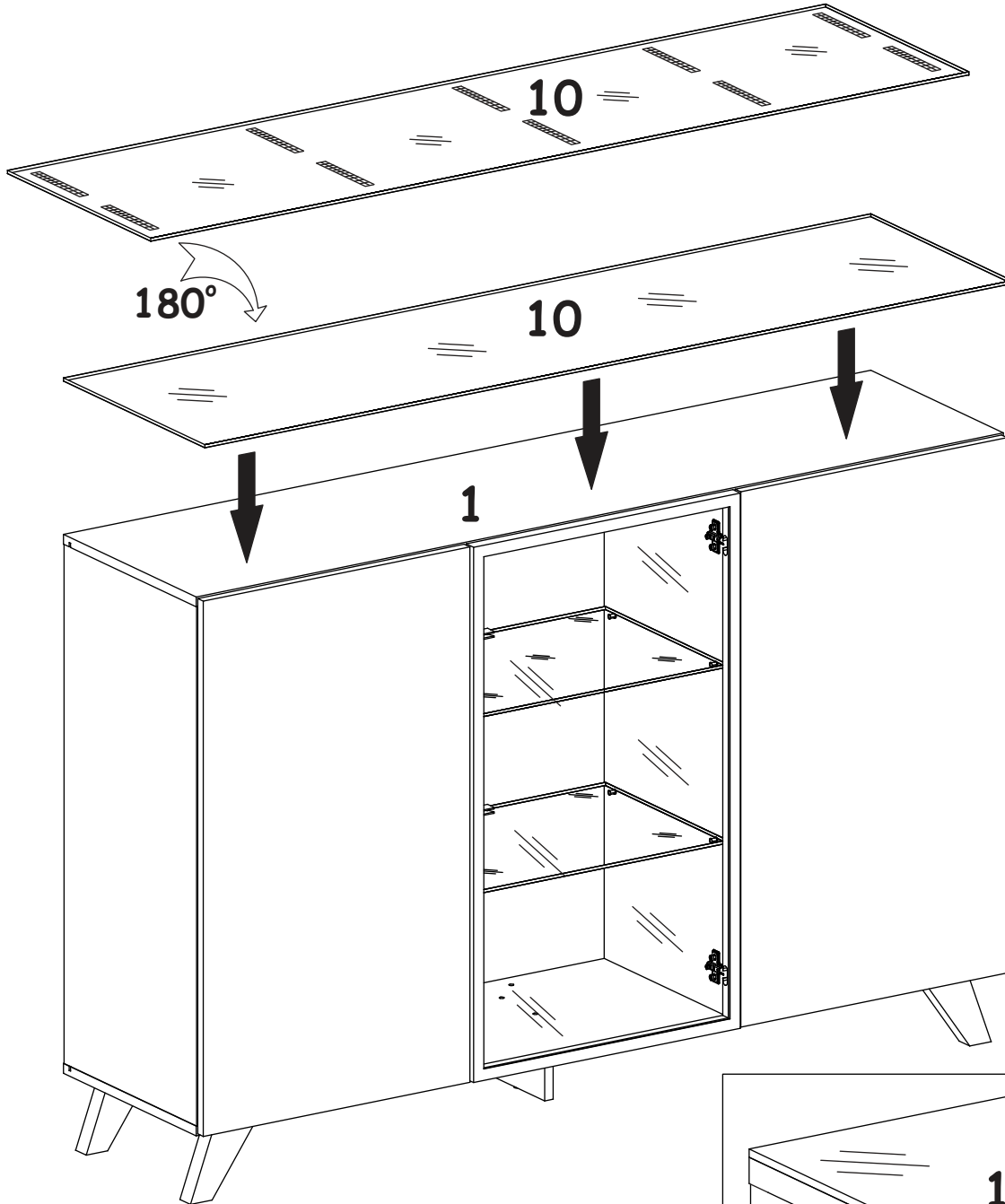

THIN 27_THWSN

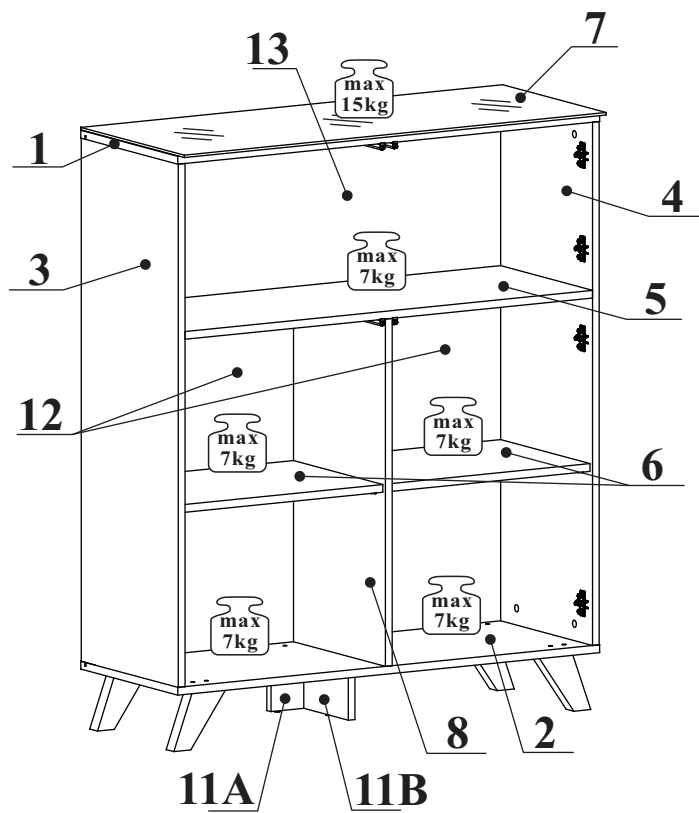
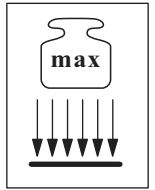
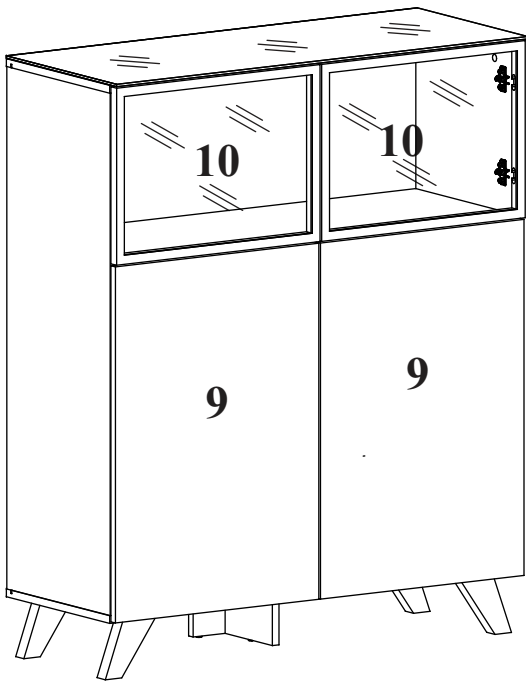



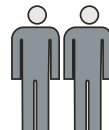
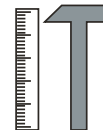
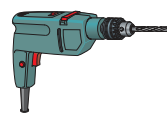





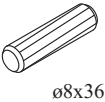
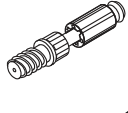
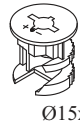

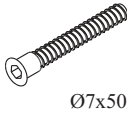

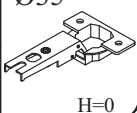
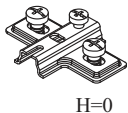
NO	Dim.[mm]			Col.-No	Qty
1	1002	376	16	1	1
2	1002	376	16	1	1
3	1074	376	16	1	1
4	1074	376	16	1	1
5	968	356	16	1	1
6	476	346	16	1	2
7	1002	401	5	1	1
8	713	356	16	1	1
9	496	732	16	2	2
10	496	364	21	2	2
11A	115	172	16	1	1
11B	115	172	16	1	1
12	490	727	3	2	2
13	980	359	3	1	1

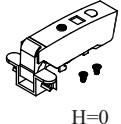
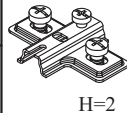
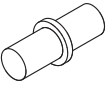
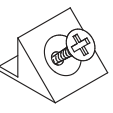
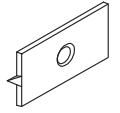

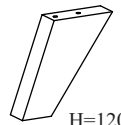
90 min

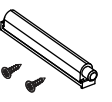
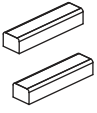
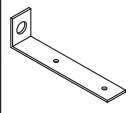
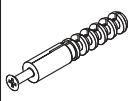
THIN 27_THWSN

A1 x16  ø8x36	B4 x16 	B5 x16  Ø15x12	G5 x16 	B11 x14  Ø7x50	G4 x14 
E21 x4 Ø35  H=0	E2 x4  H=0	D10 x18  USØ3,5x13	E30 x4  H=0	E4 x4  H=2	G7 x8 
S1 x16 	G16 x10 	UP13 x10  UPØ3x16	SK x4  H=120	I2 x3 	OD1 x4 
LED X2 	L1 x1 	KR1 x1 	G2 x1 		

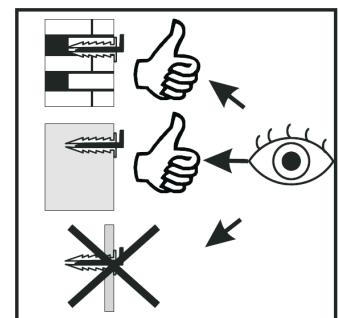
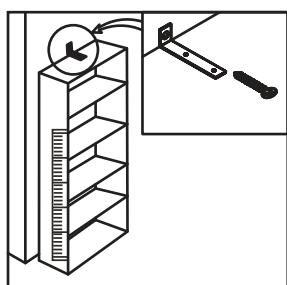
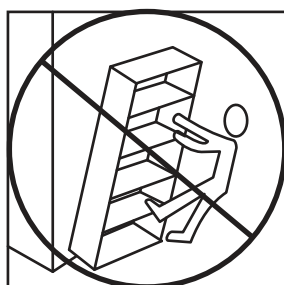
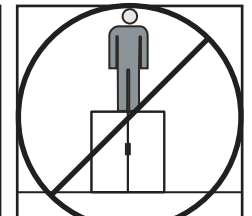
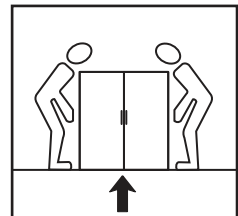
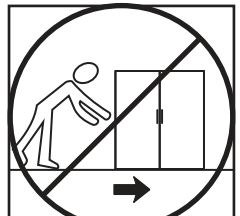
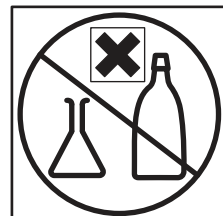
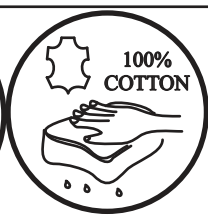
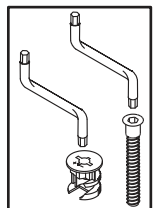
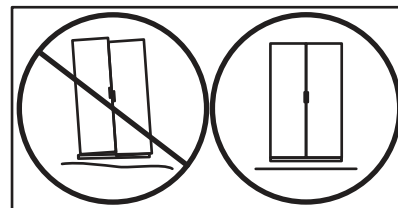
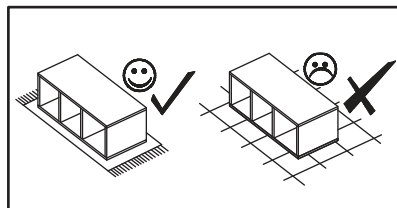
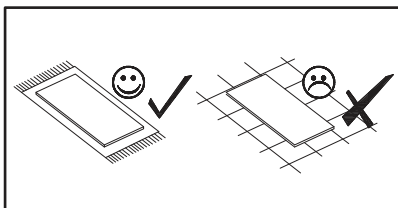
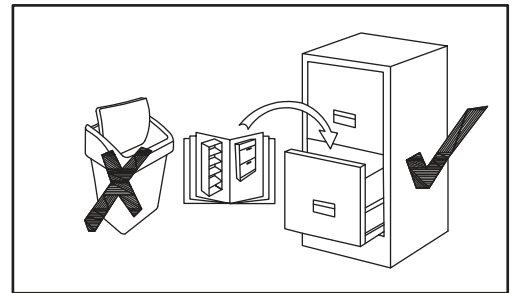
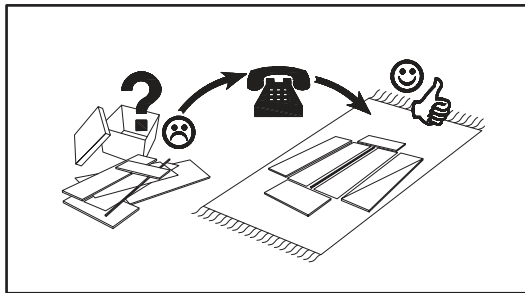
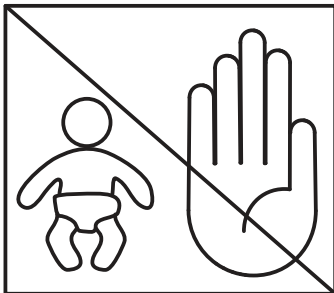
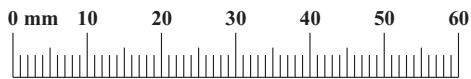

1

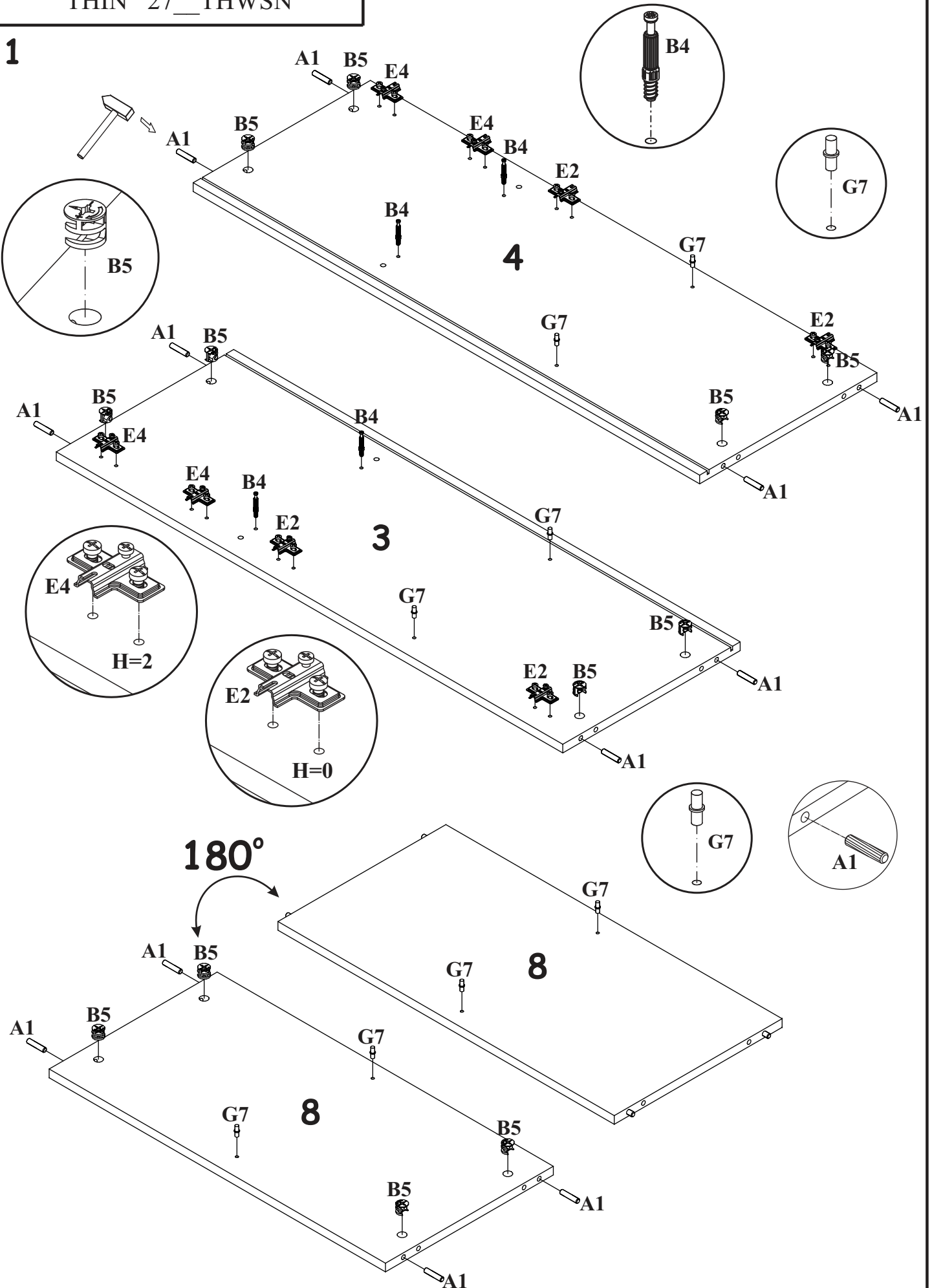

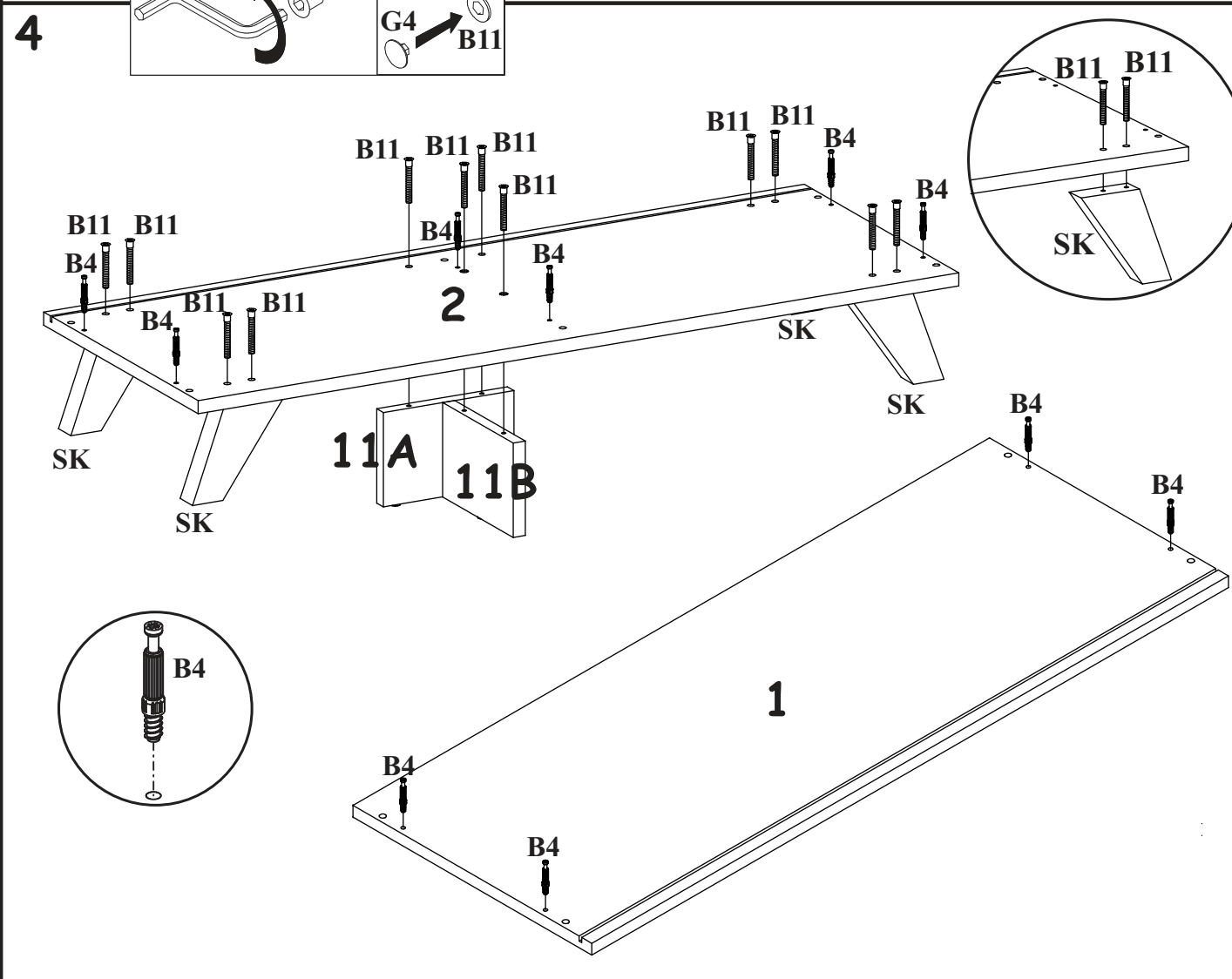
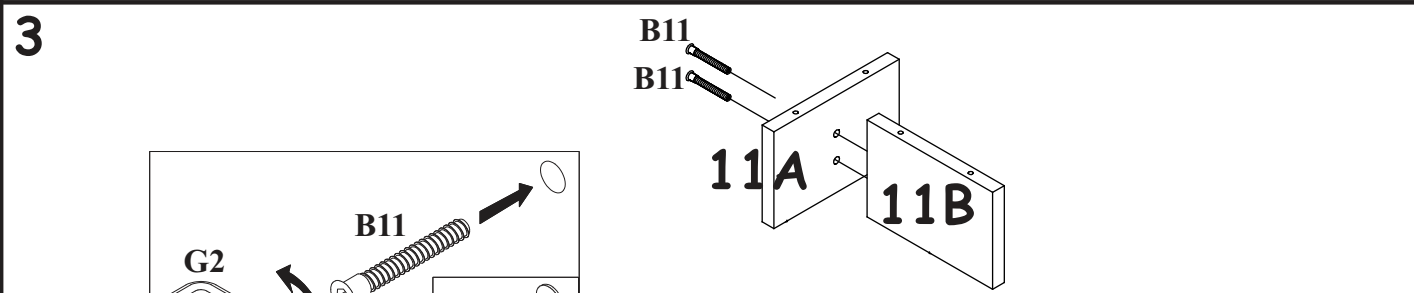
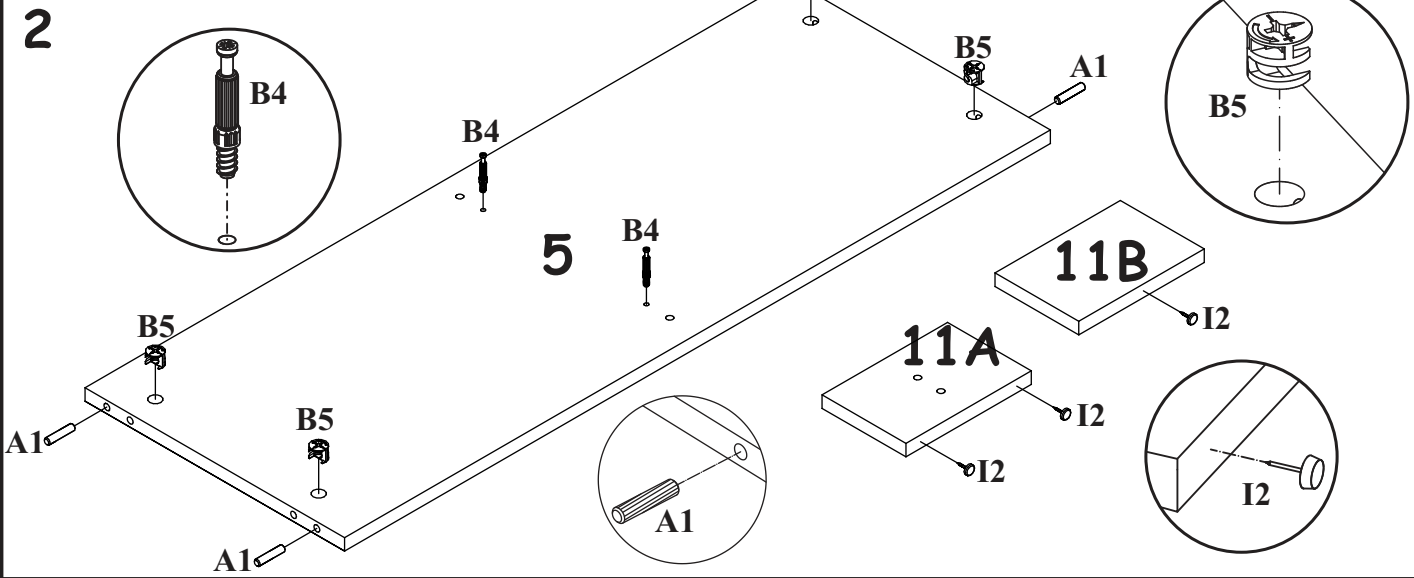

5

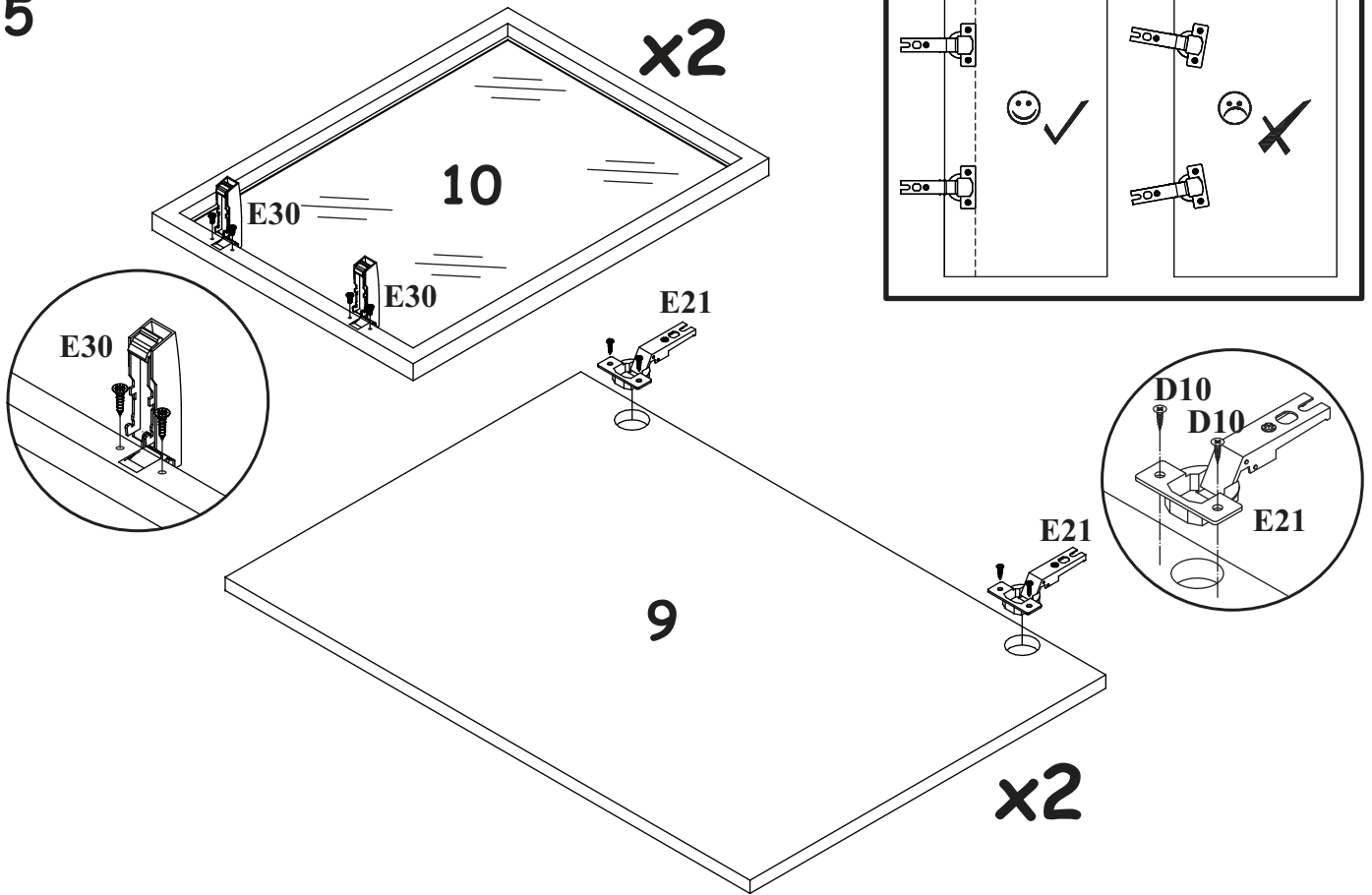

6

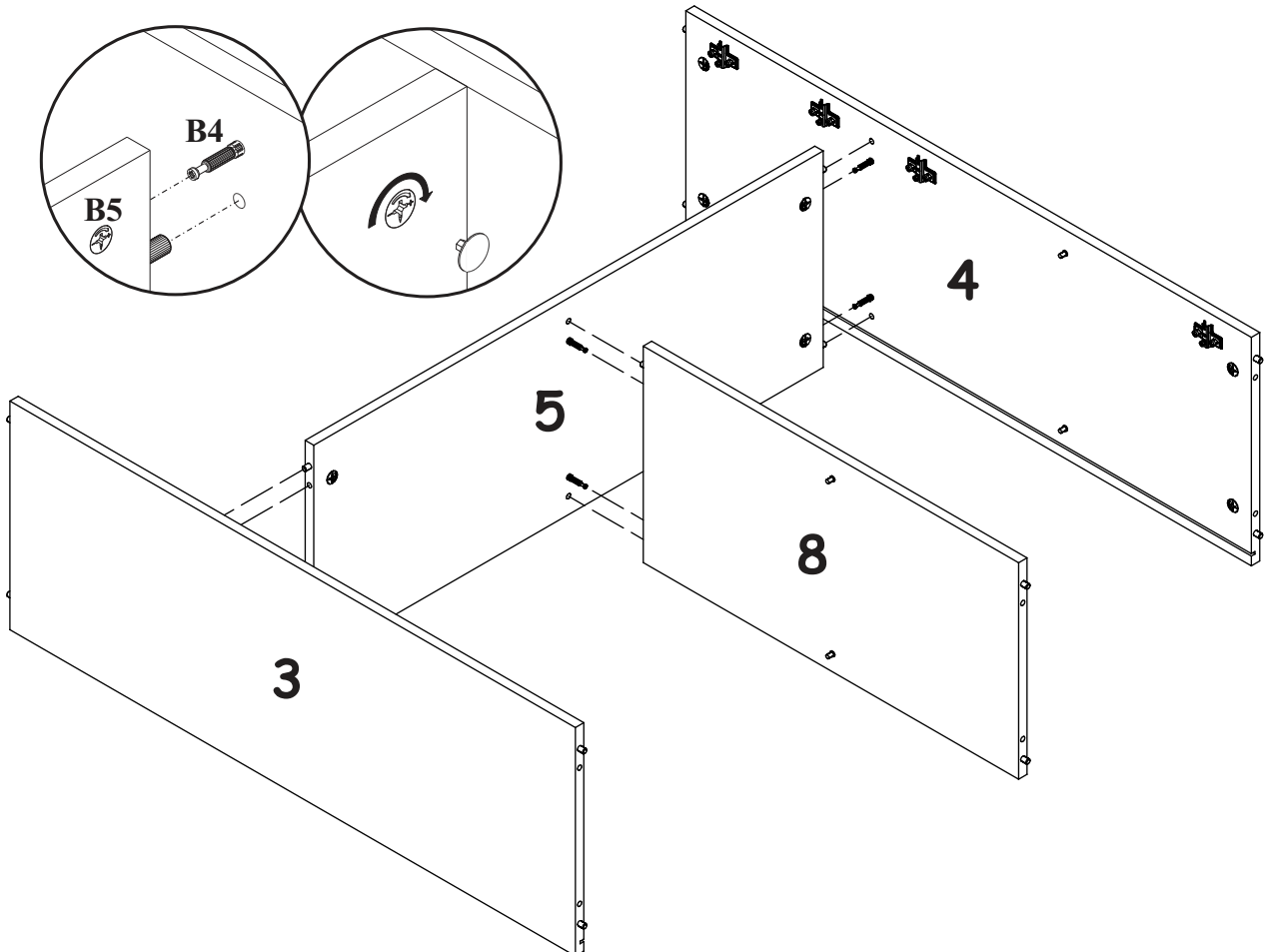

7

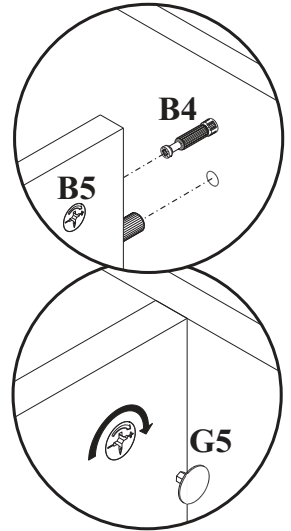
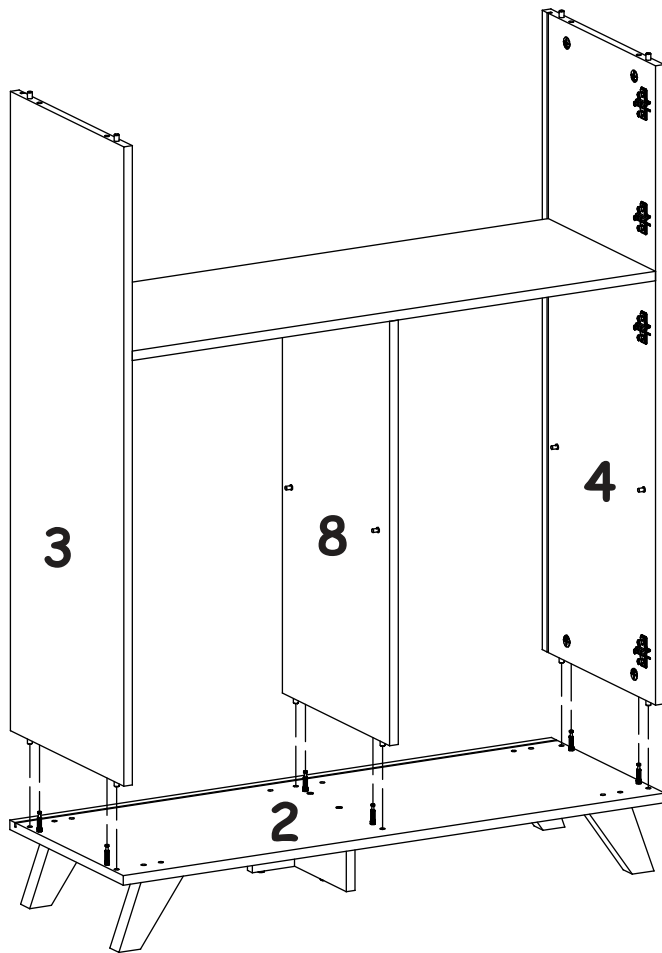

8

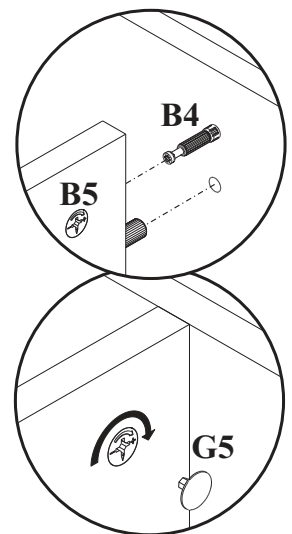
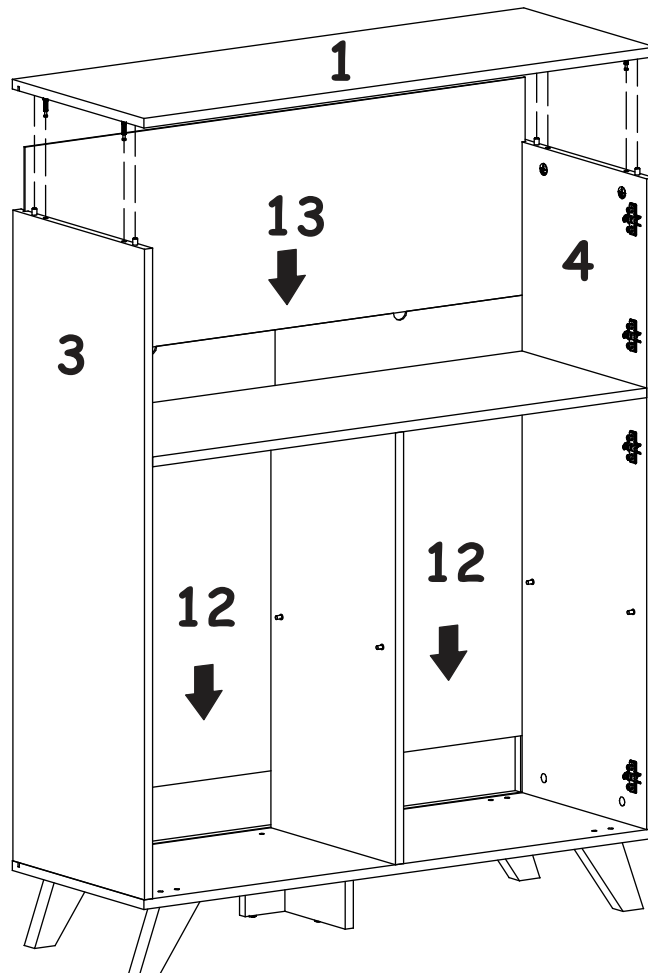

9

X=Y \uparrow 90°

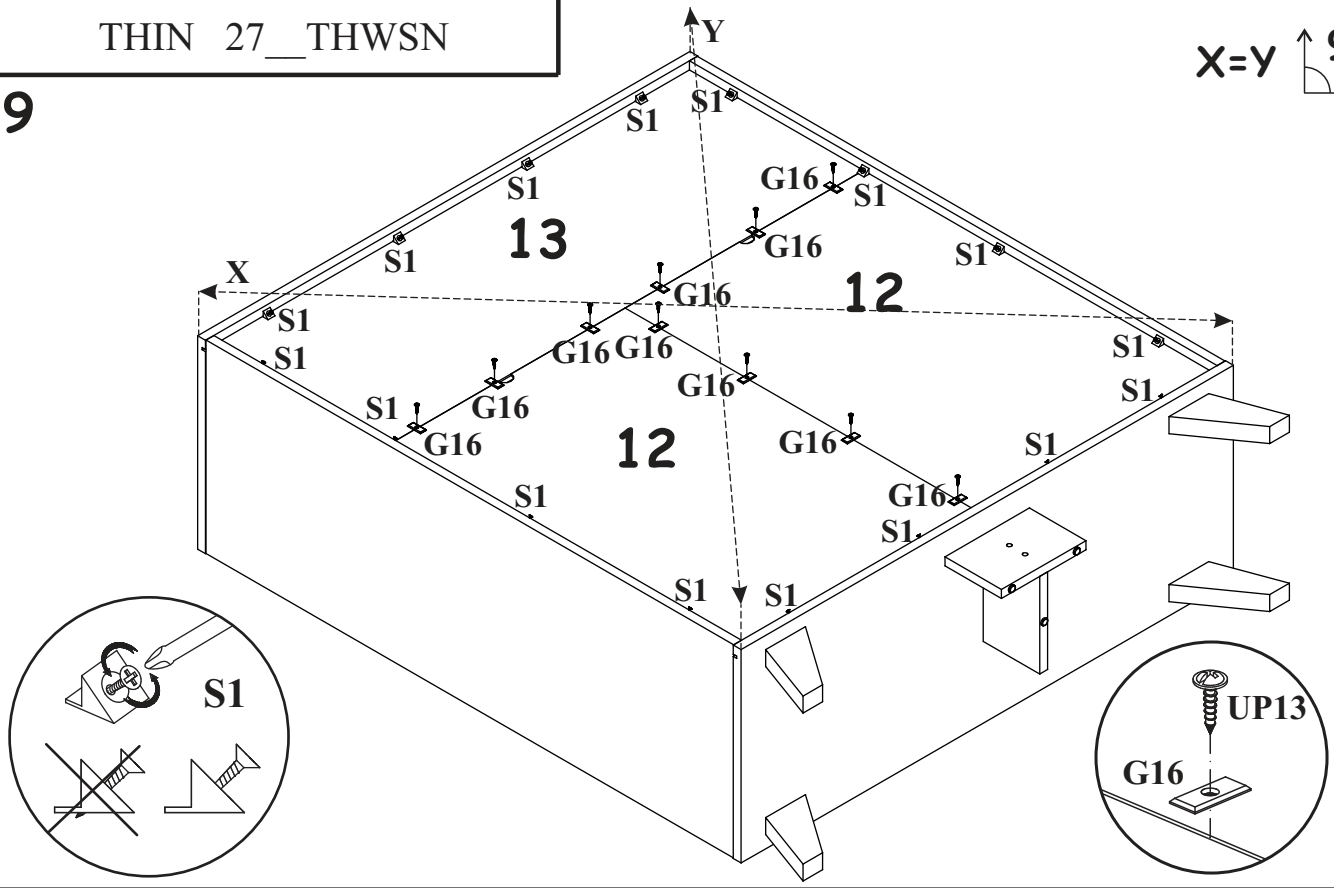

10

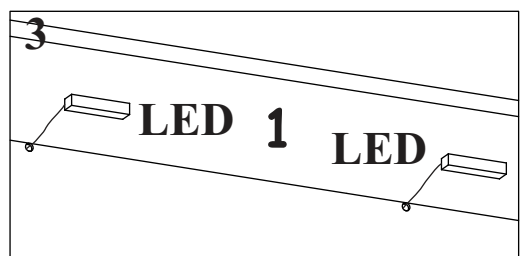
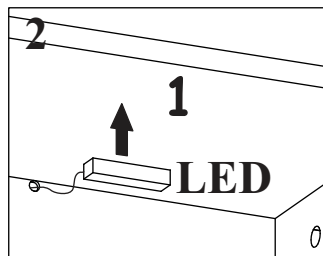
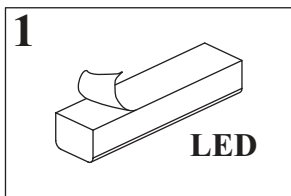
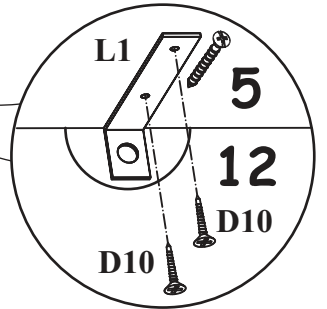
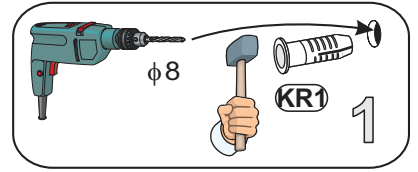
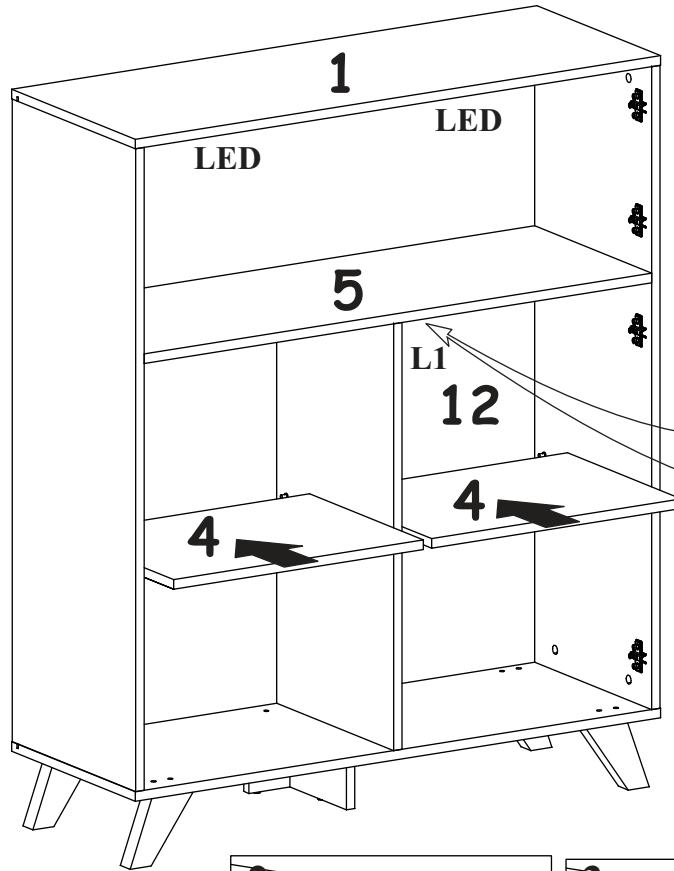
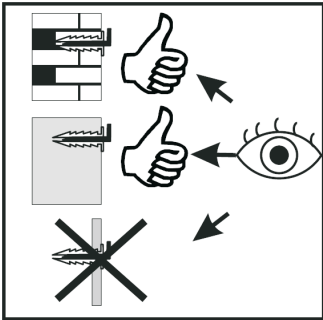

11

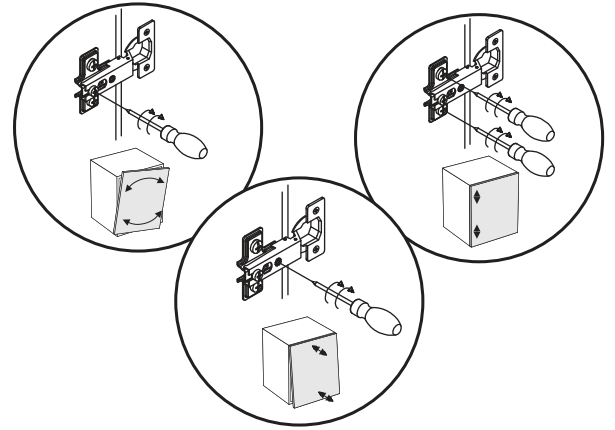
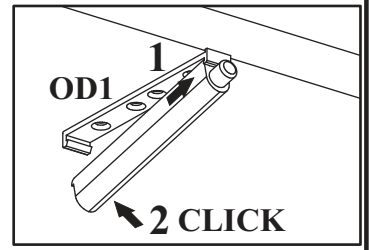
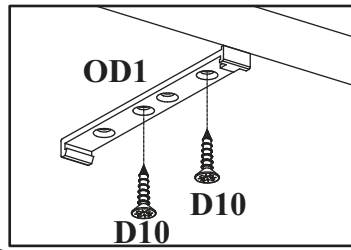
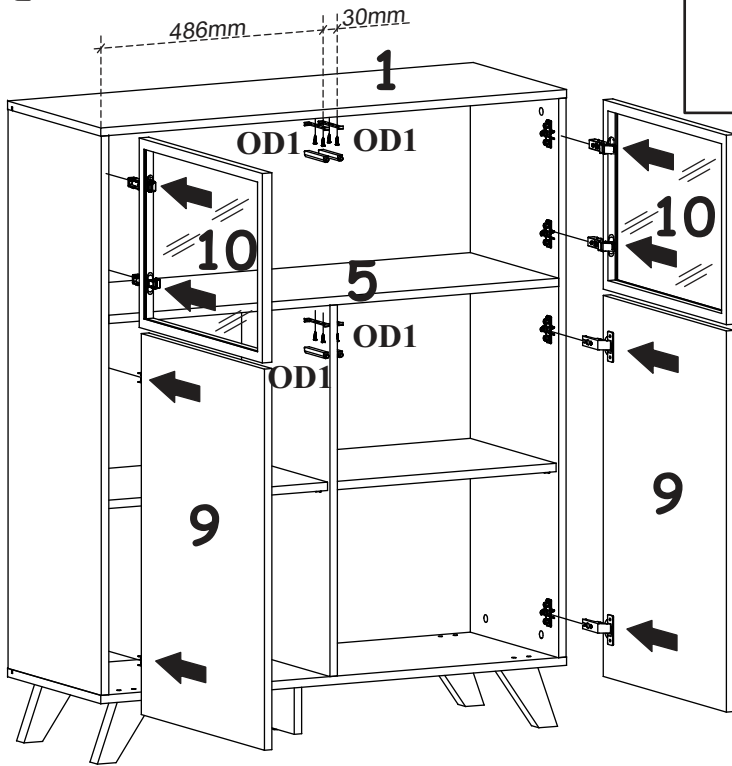

12

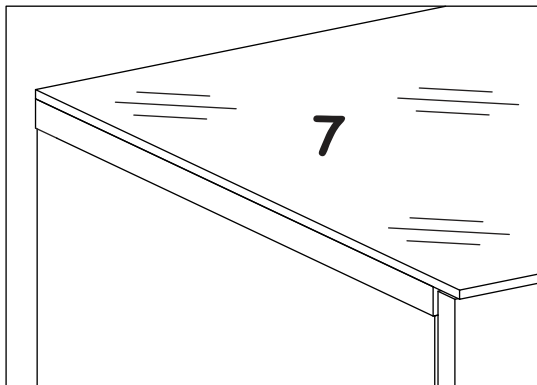
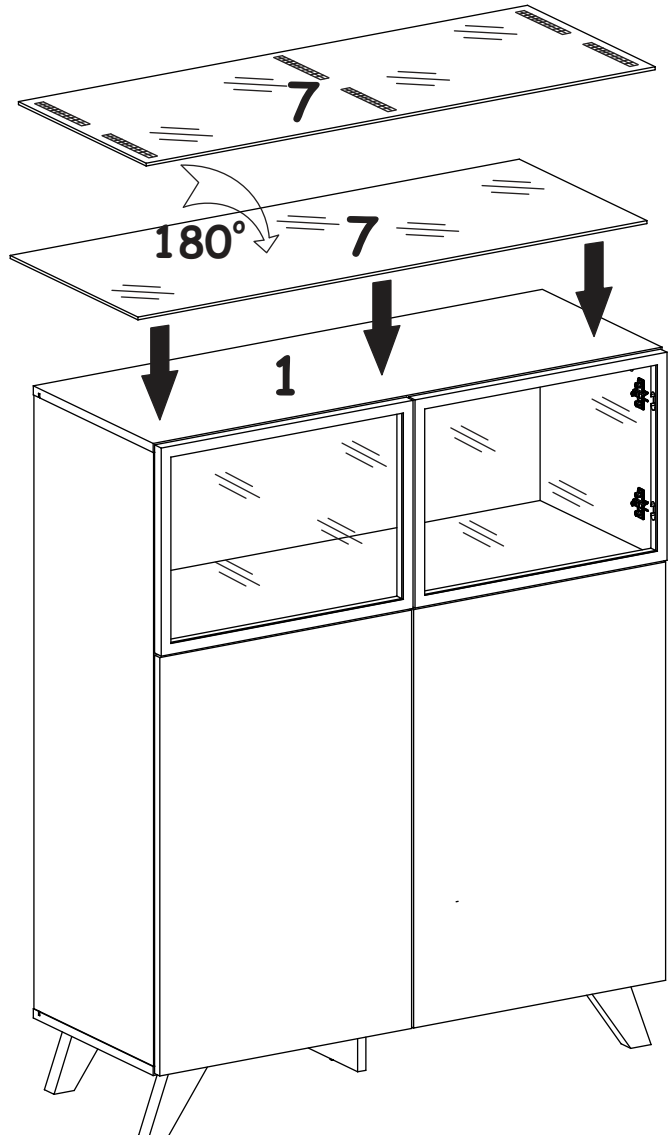
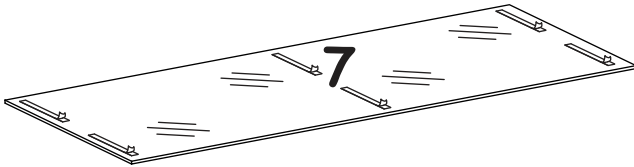
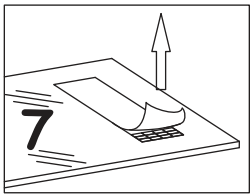

THIN 27_THWSW

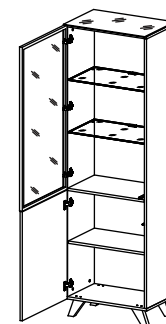
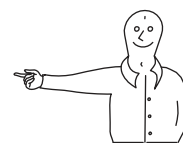
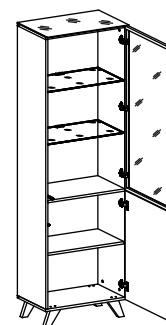
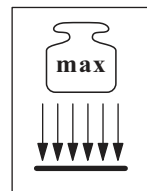
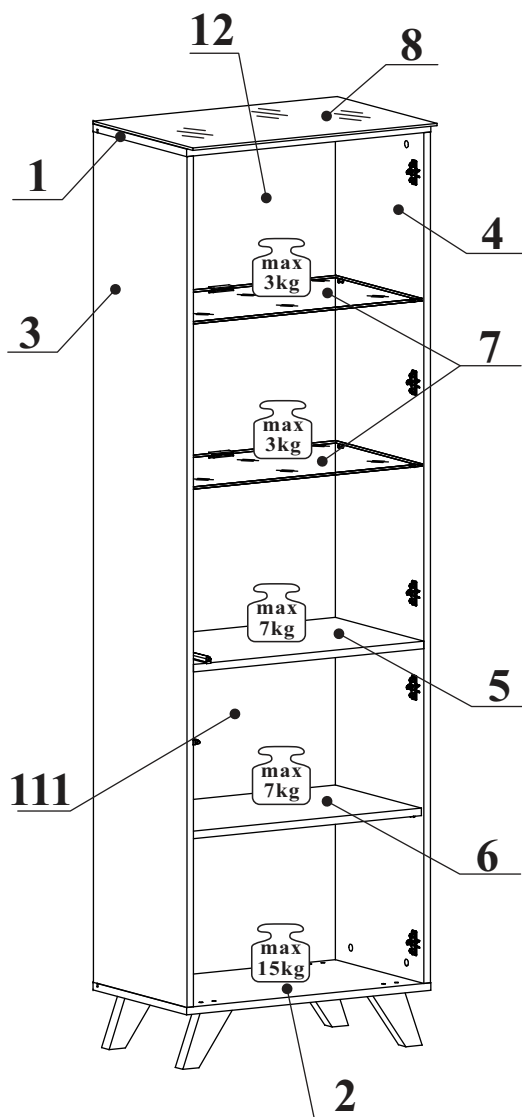
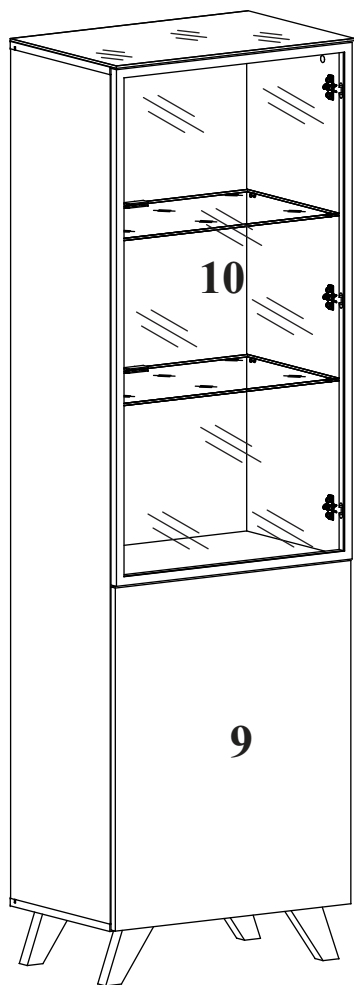



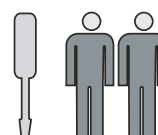





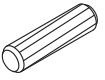
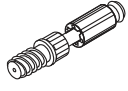



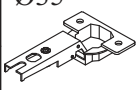
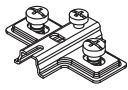
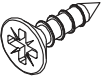
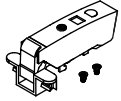
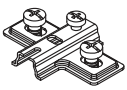

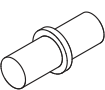
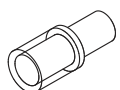
NO	Dim.[mm]			Col.-No	Qty
1	602	376	16	2	1
2	602	376	16	2	1
3	1812	376	16	2	1
4	1812	376	16	2	1
5	568	356	16	1	1
6	568	346	16	1	1
7	567	346	5	1	2
8	602	401	5	1	1
9	596	732	16	1	1
10	596	1102	21	1	1
111	580	727	3	1	1
12	1097	580	3	1	1

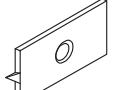

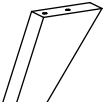
90 min

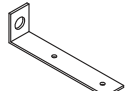
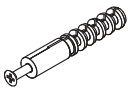
THIN 27_THWSW

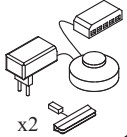
A1 x12  ø8x36	B4 x12 	B5 x12  Ø15x12	G5 x12 	B11 x8  Ø7x50	G4 x8 
E21 x2 Ø35  H=0	E2 x2  H=0	D10 x10  USØ3,5x13	E30 x3  H=0	E4 x3  H=2	Z2 x10  Ø5
G7 x4 	G20 x8 	S1 x16 	G16 x4 	UP13 x4  UPØ3x16	SK x4  H=120
OD1 x2 	L1 x1 	KR1 x1 	G2 x1 	LED x1  x2	

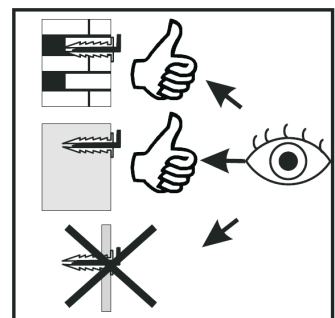
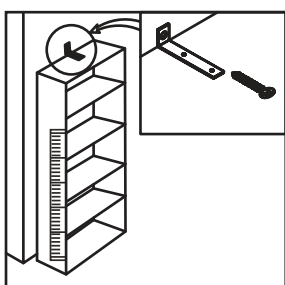
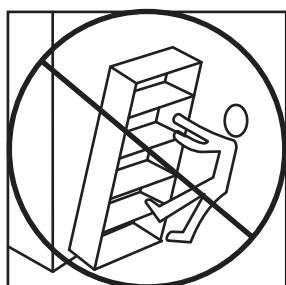
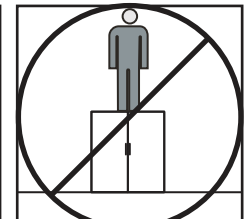
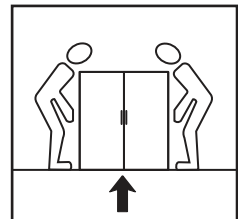
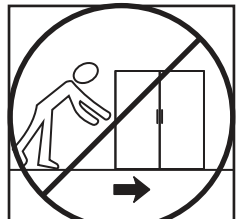
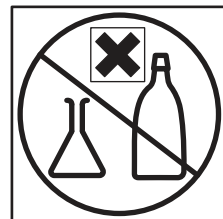
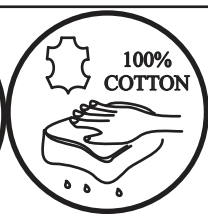
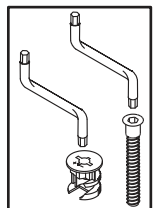
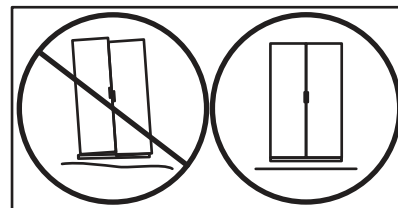
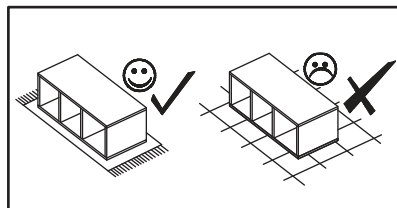
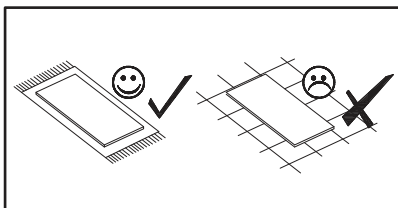
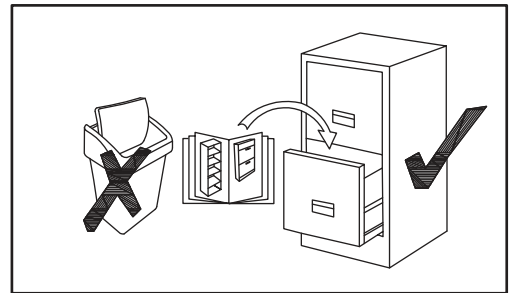
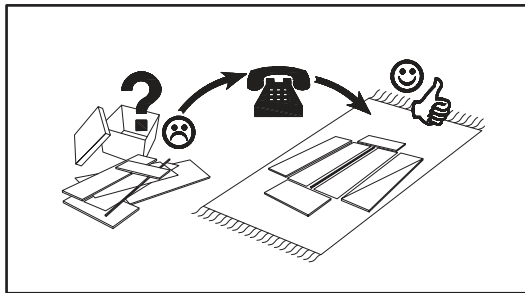
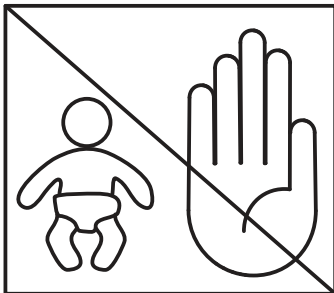
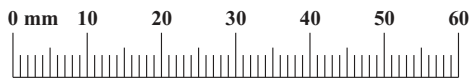

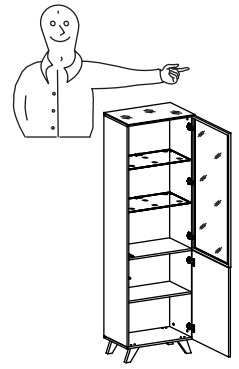

1

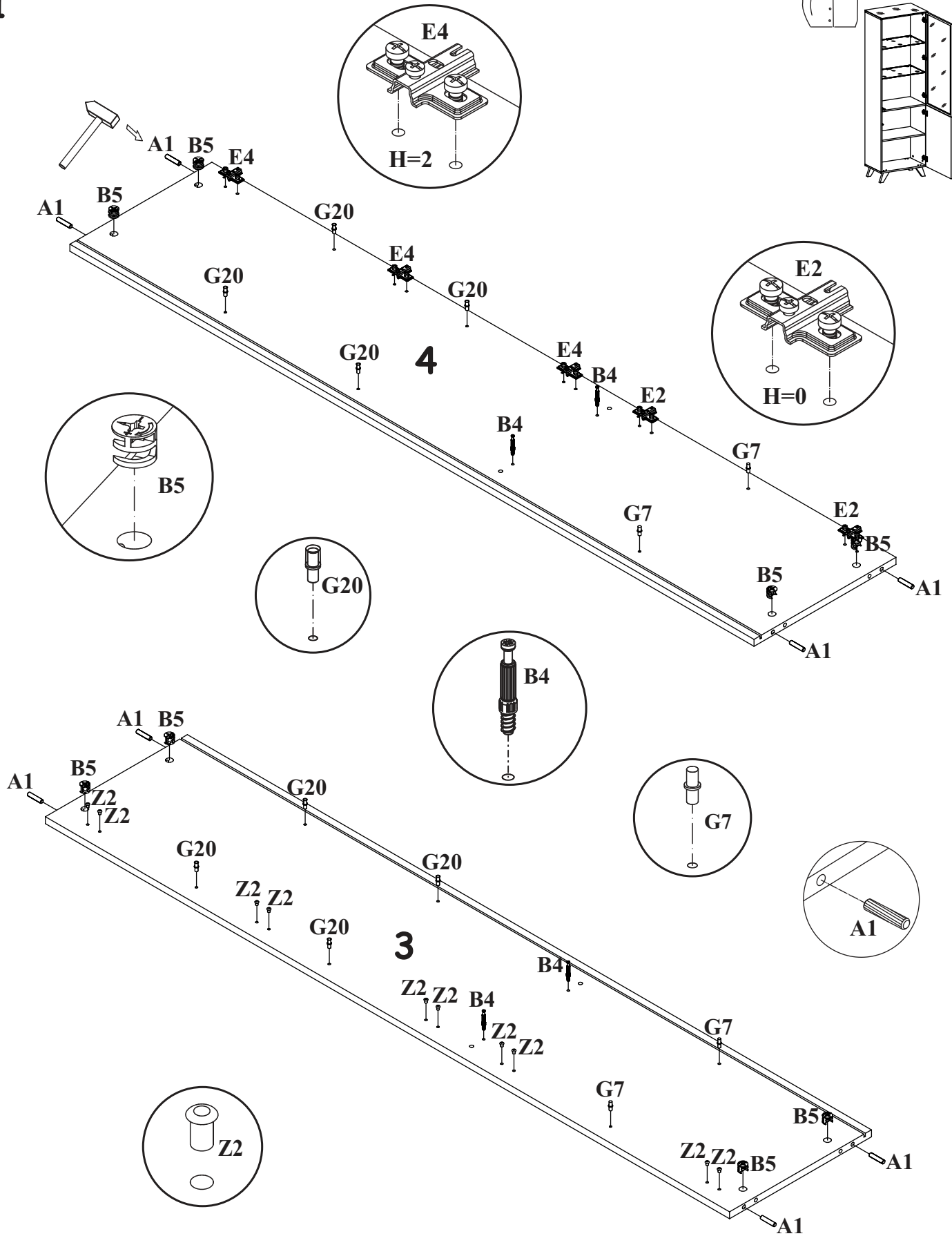

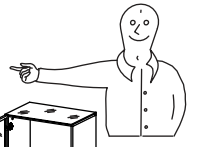

1

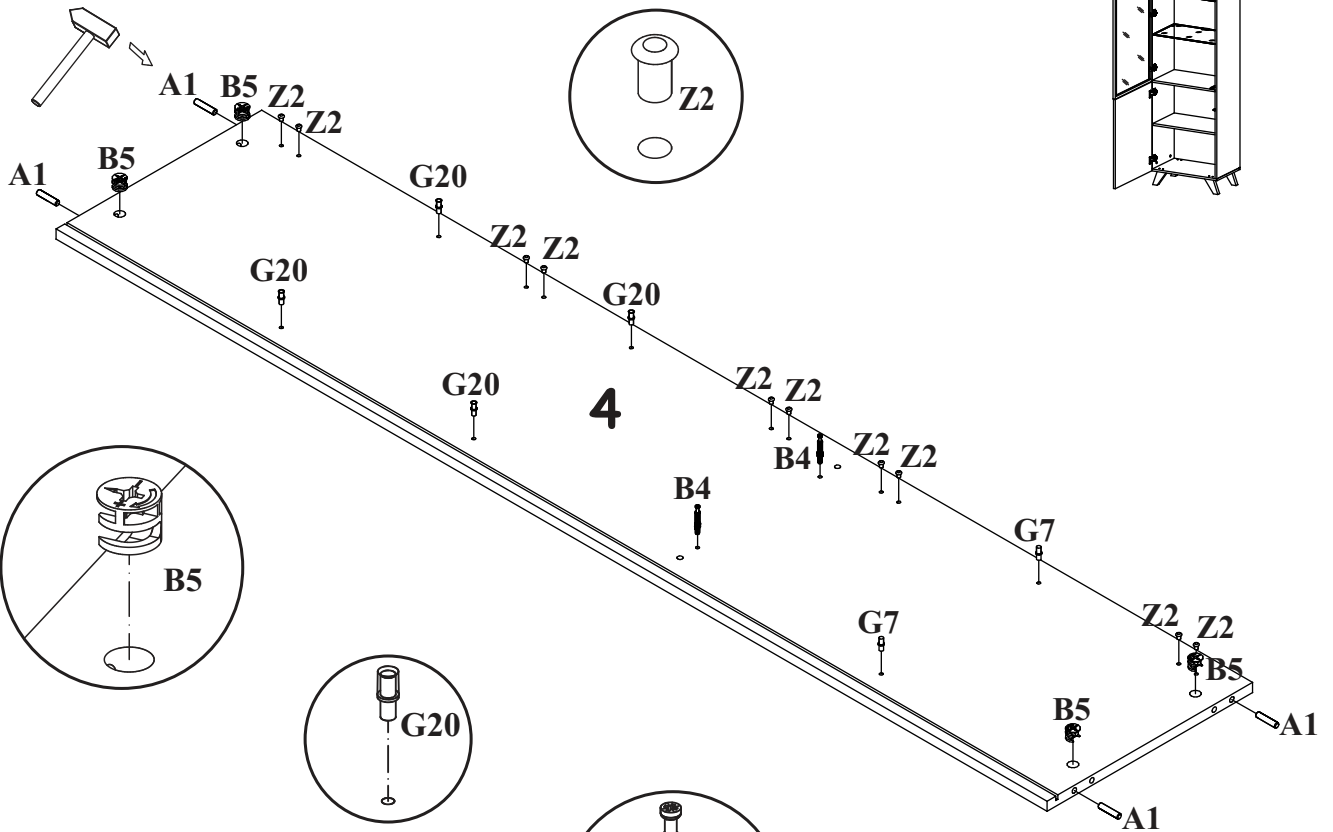

4

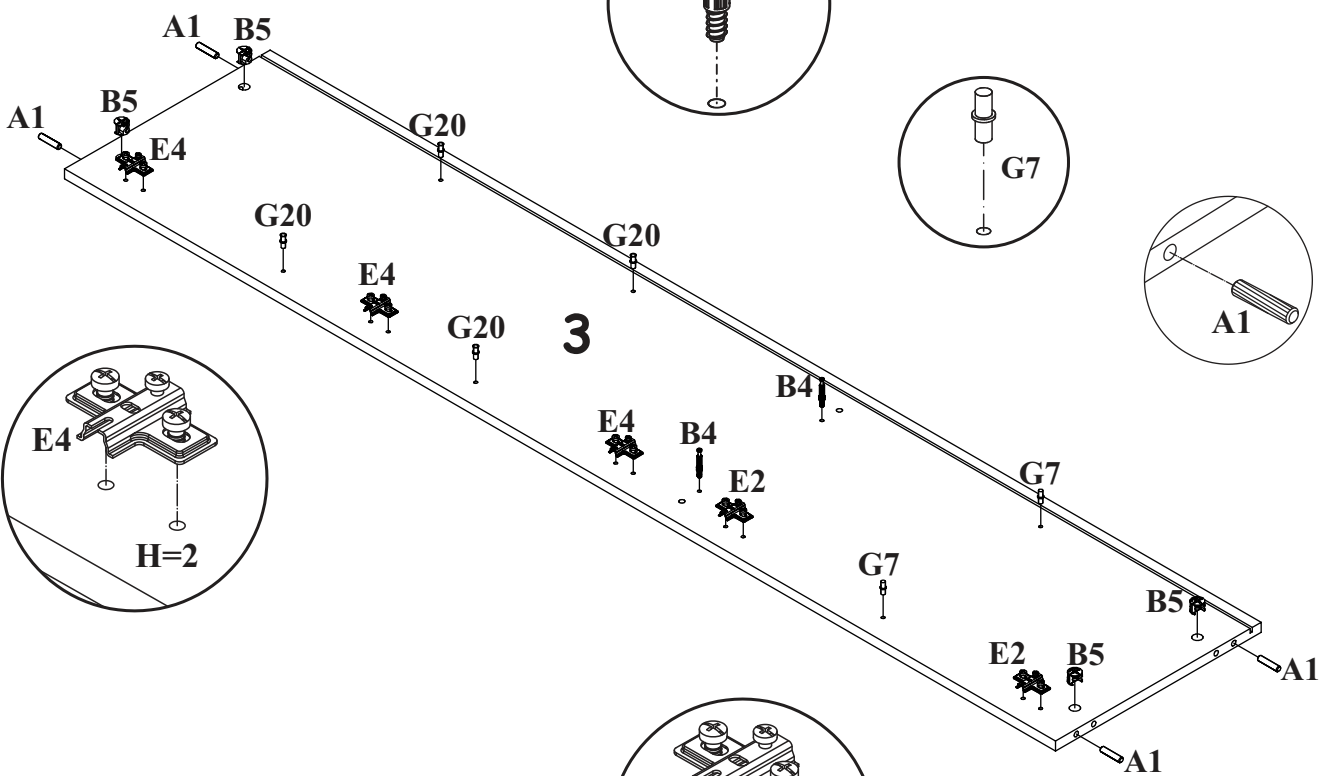

3

2

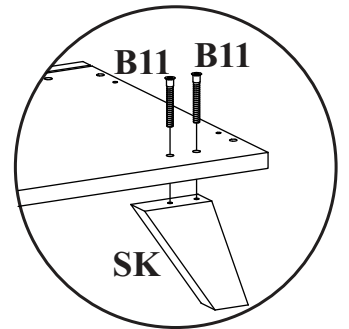
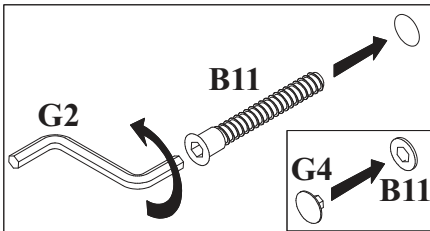
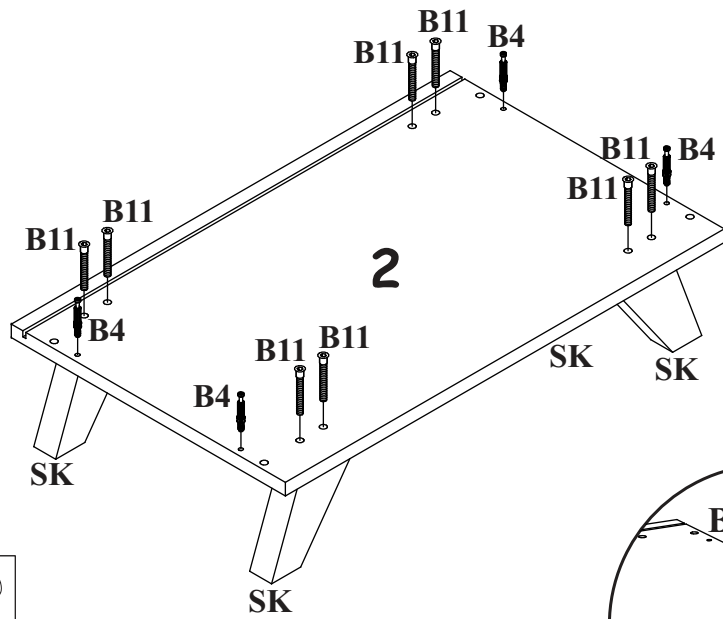
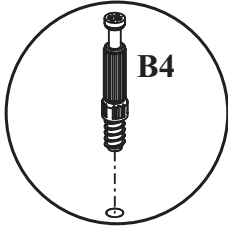
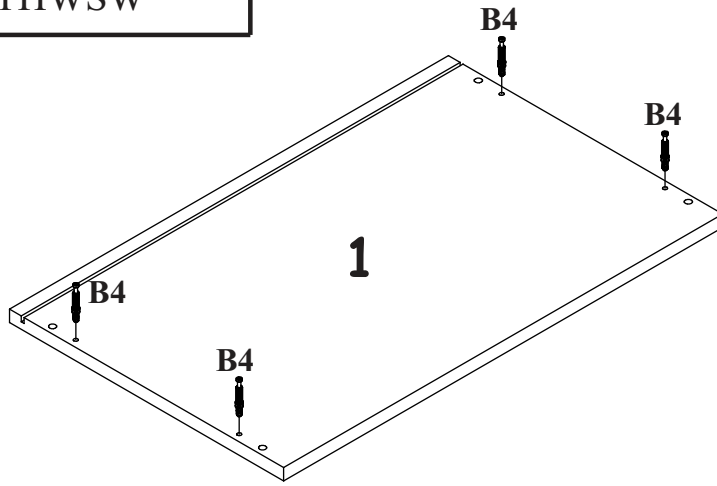

3

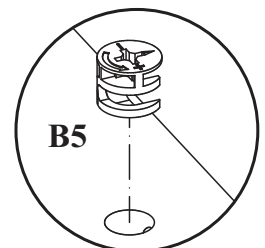
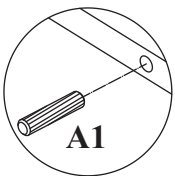
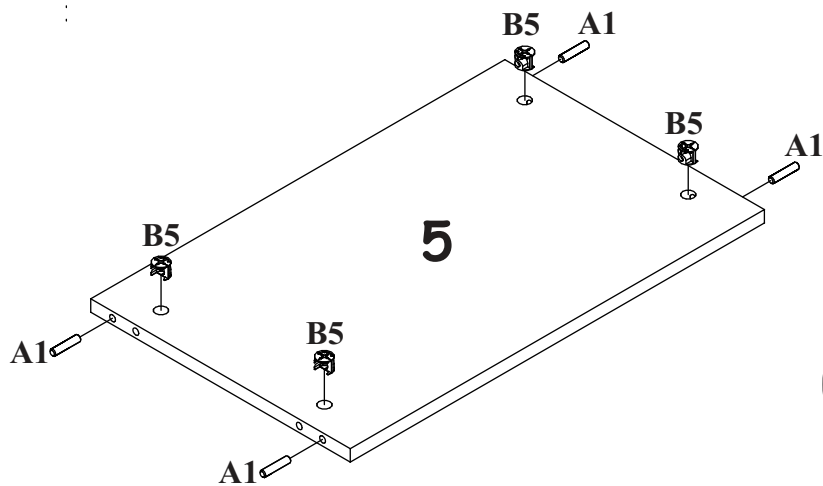

4

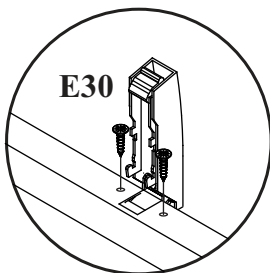
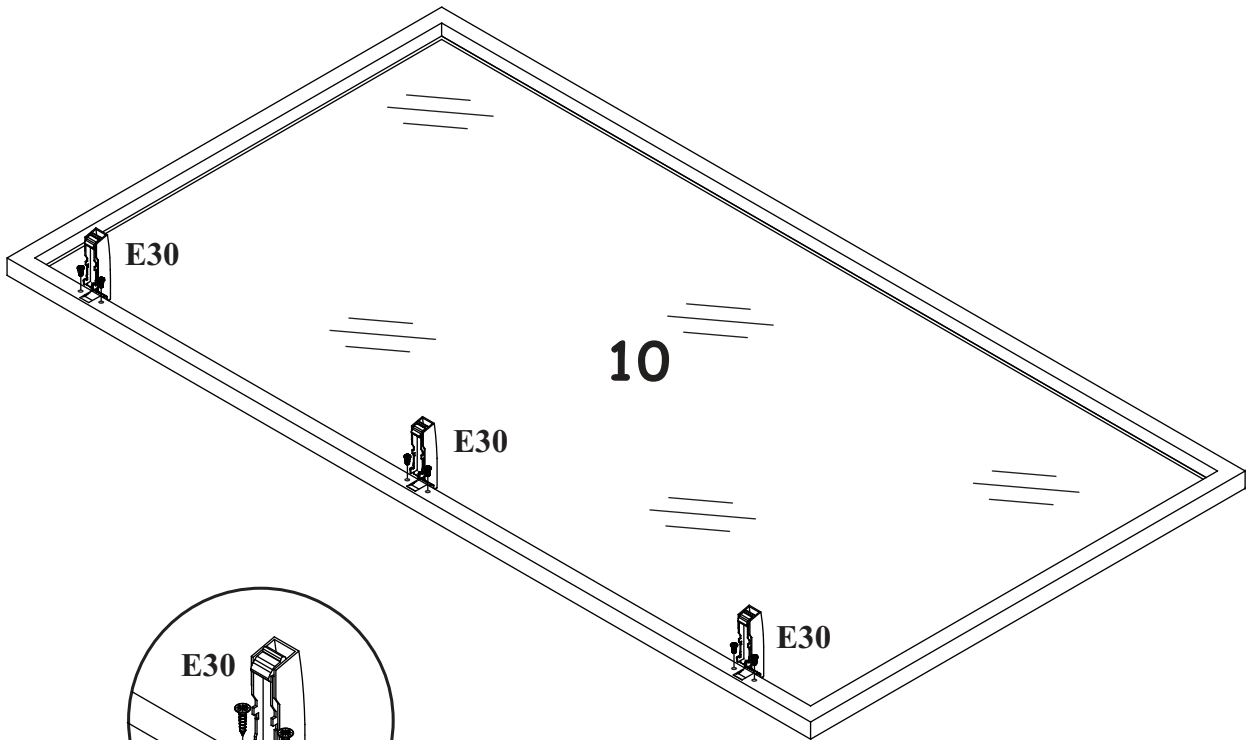
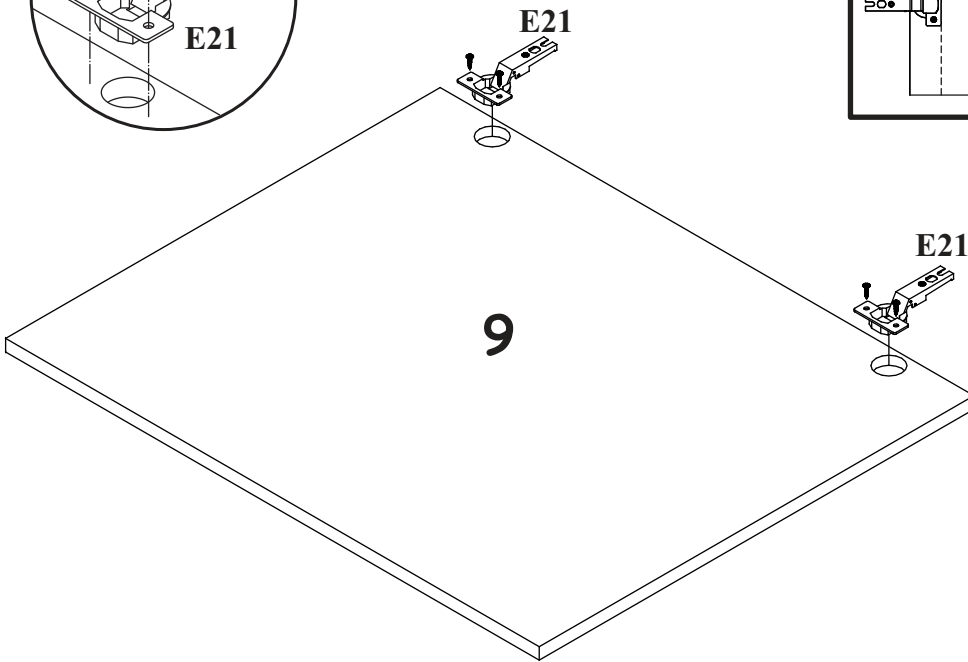
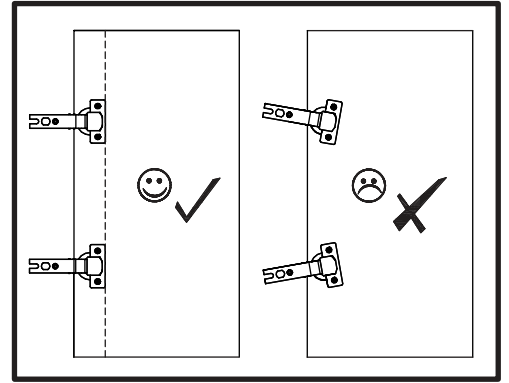
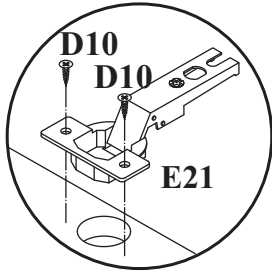

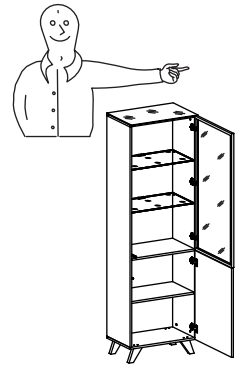

5

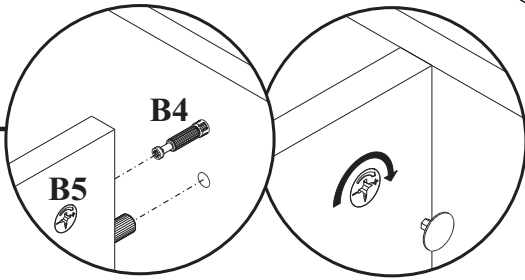
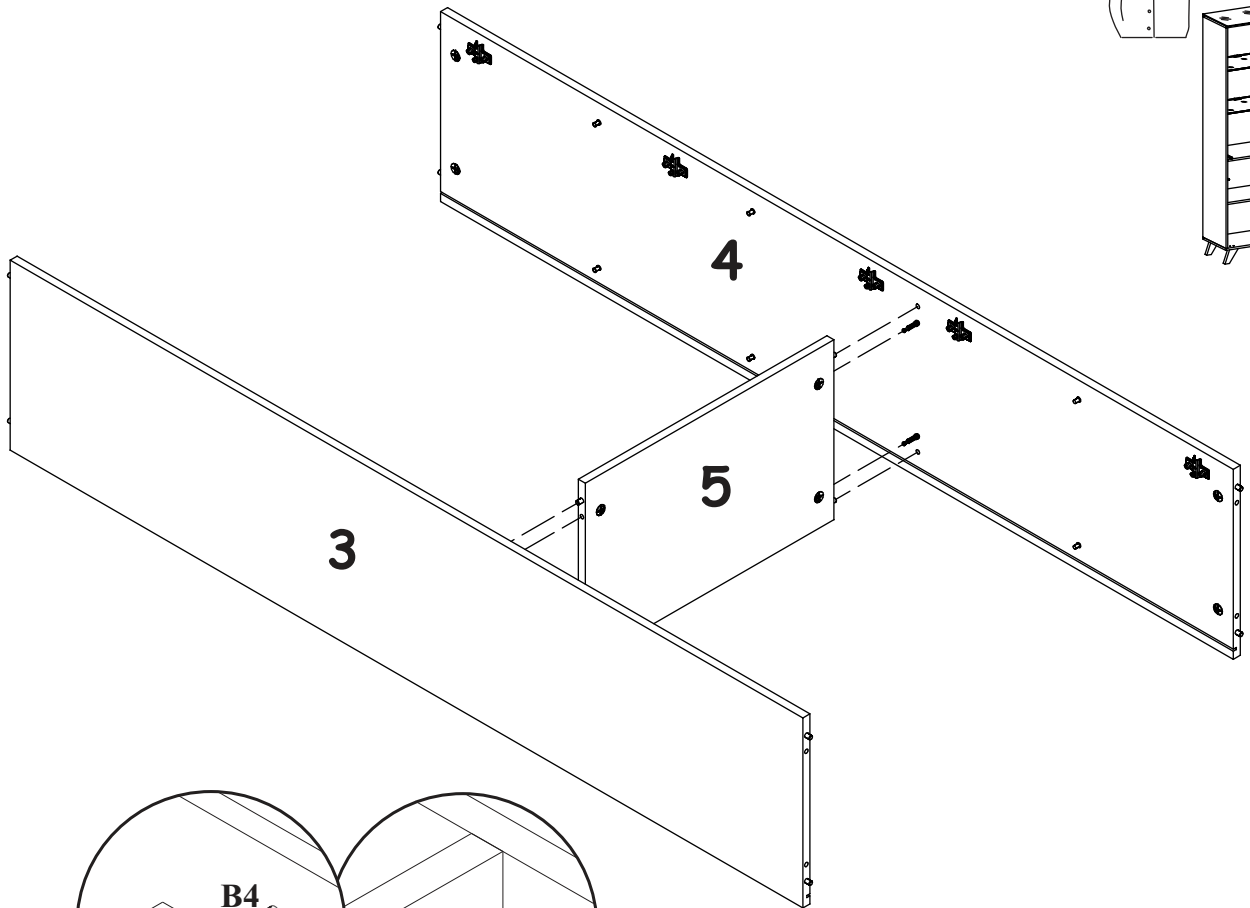

5

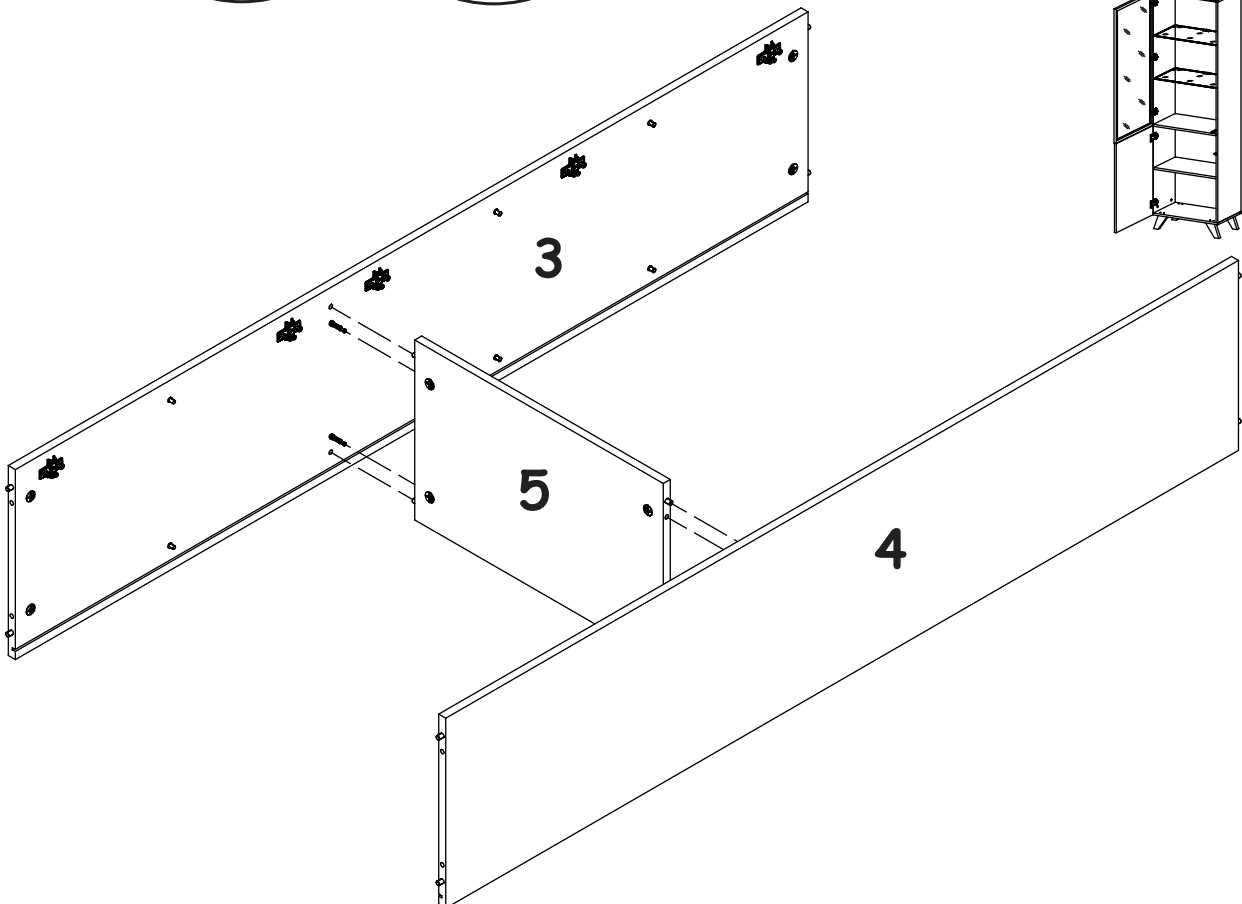
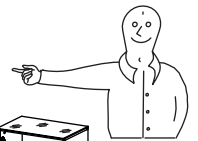

6

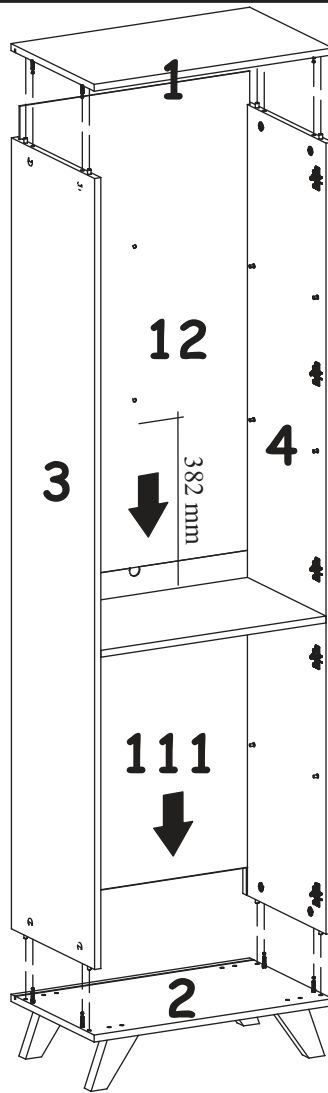
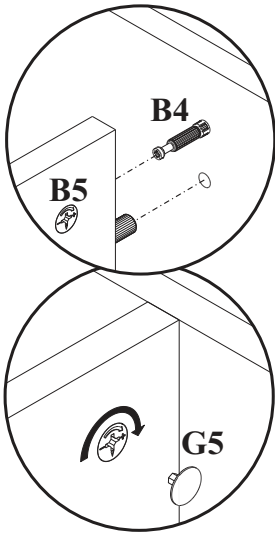

7

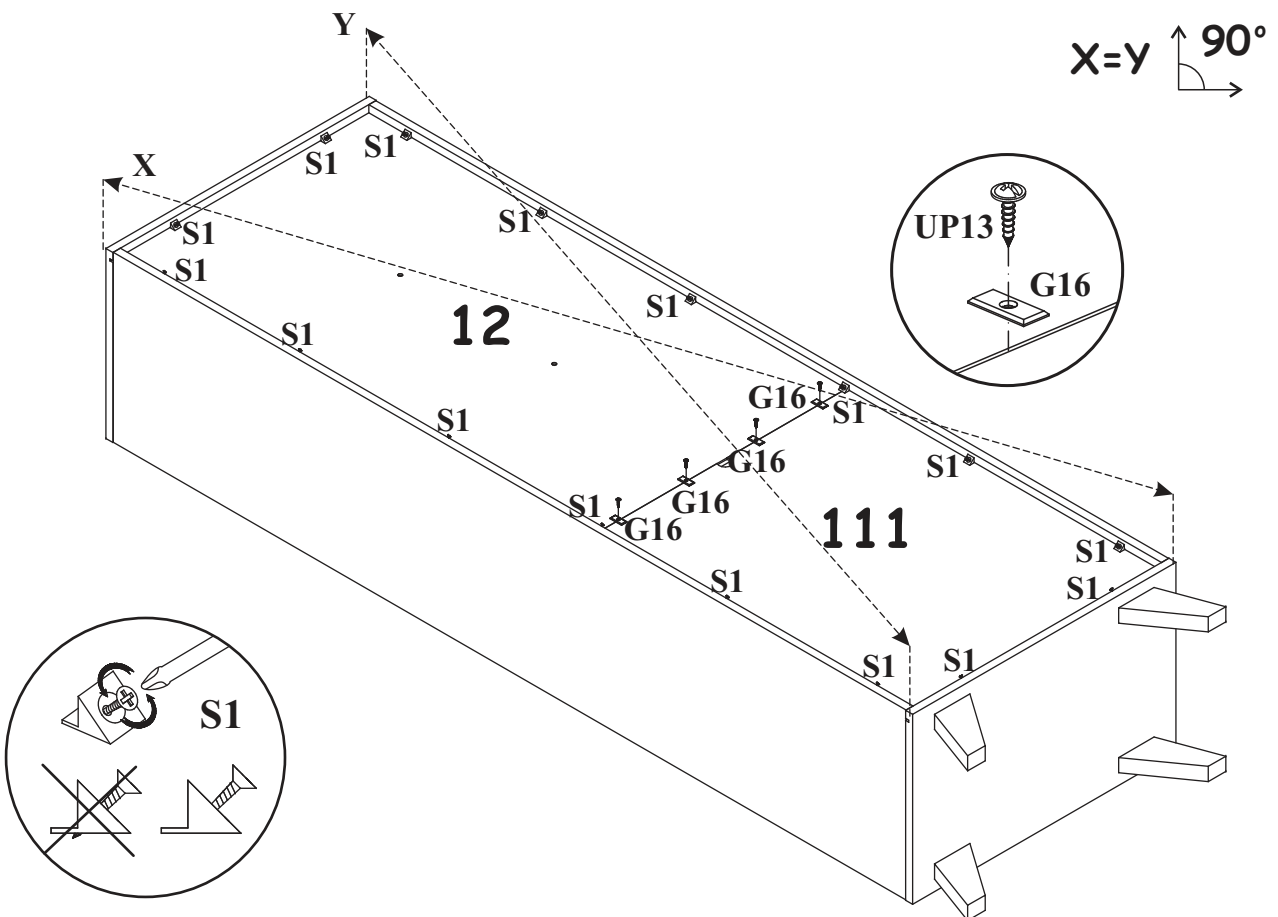

8

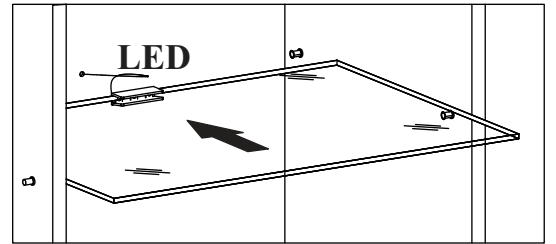
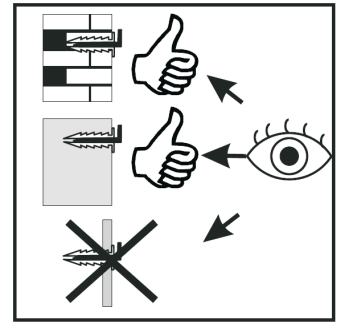
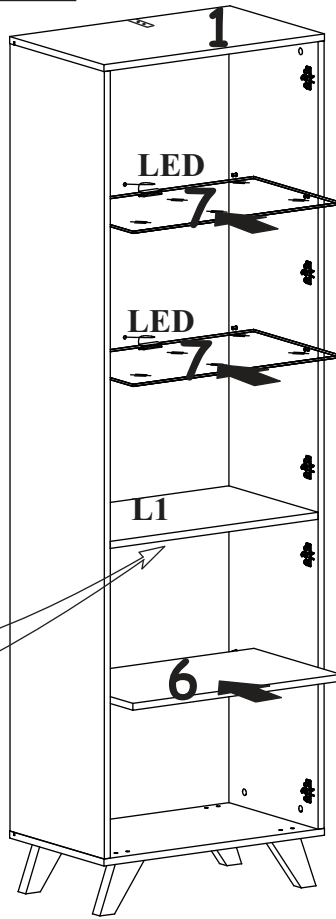
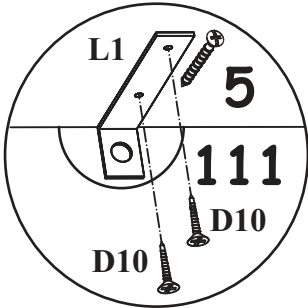
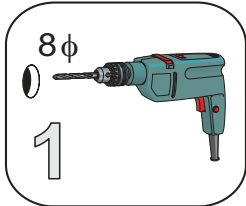

9

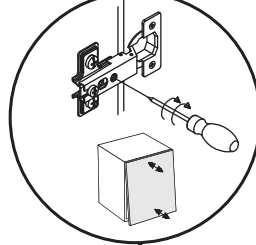
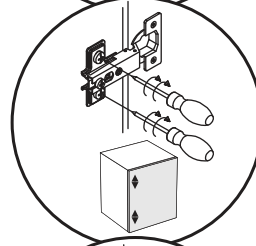
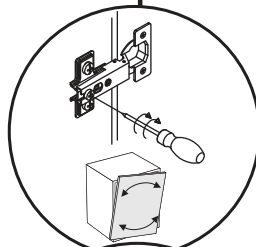
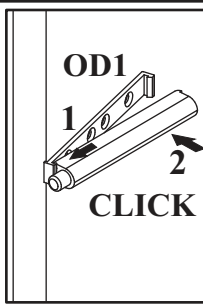
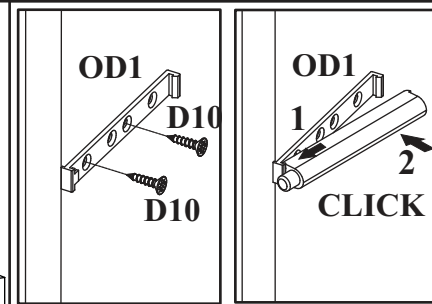
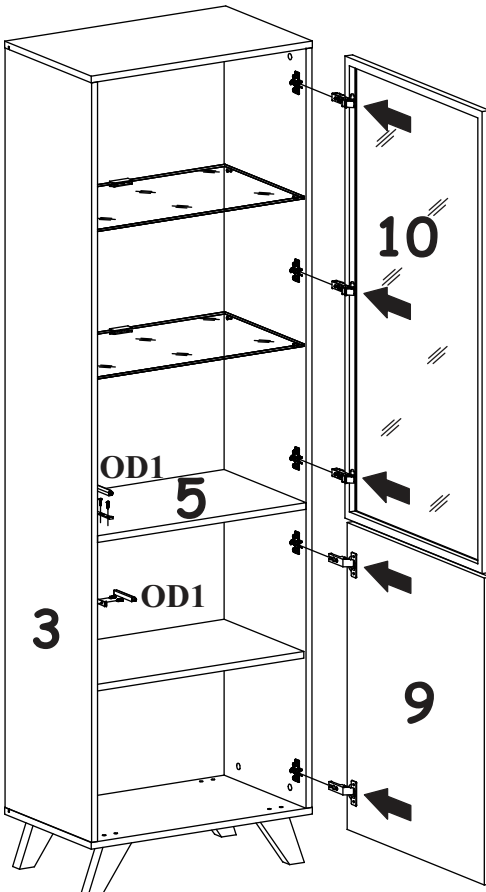
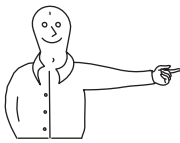

9

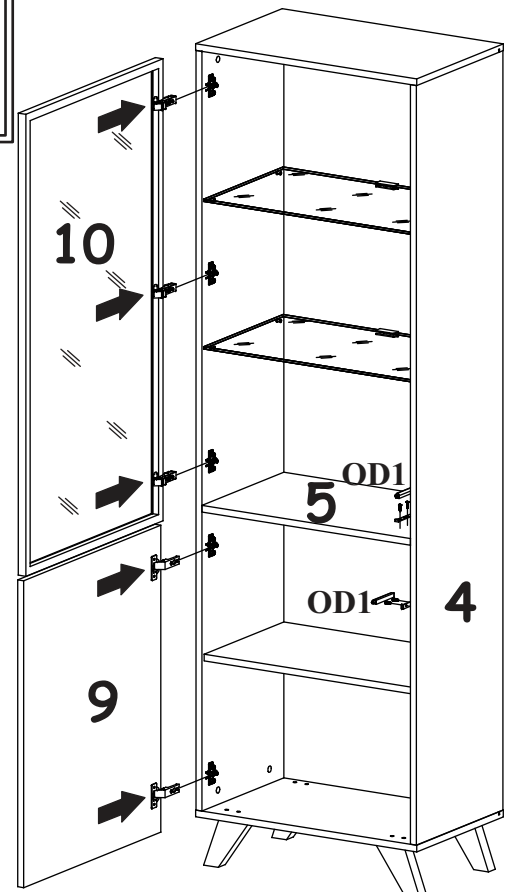
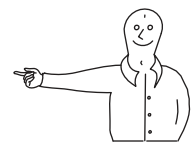

10

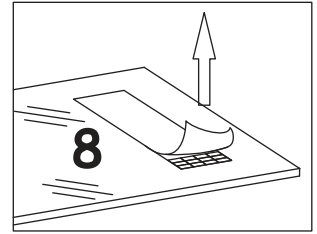
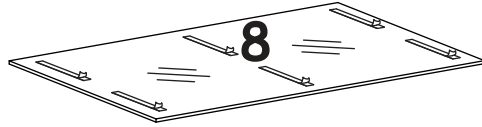

11

