

# ARMARIO 1 ECO TYP G

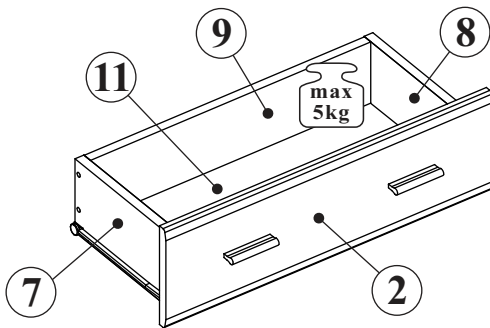

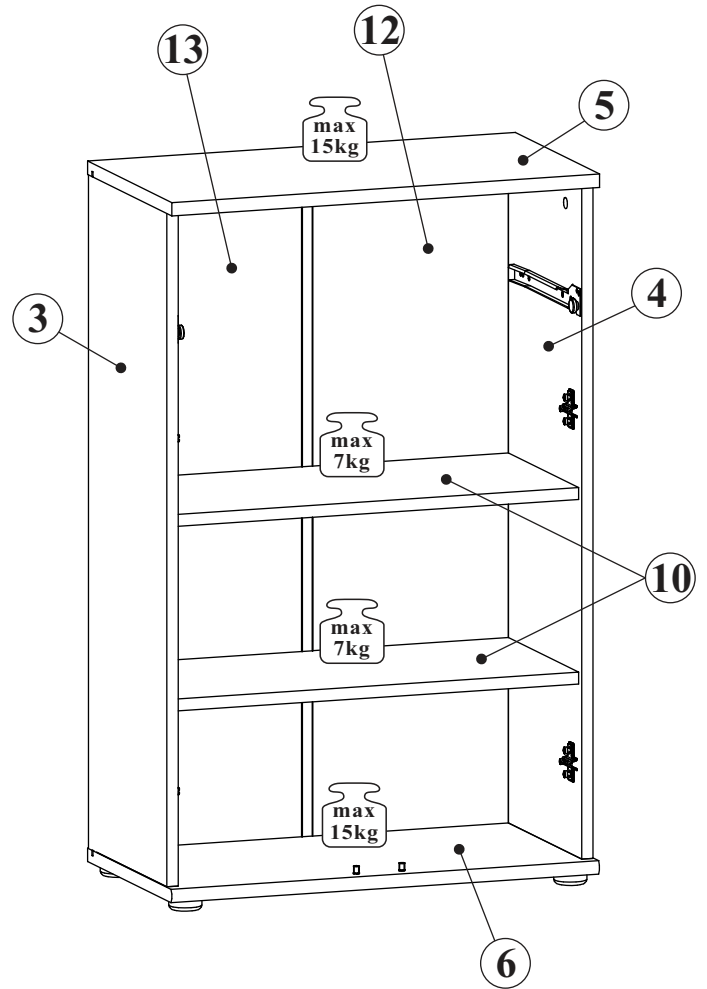

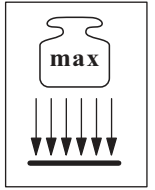

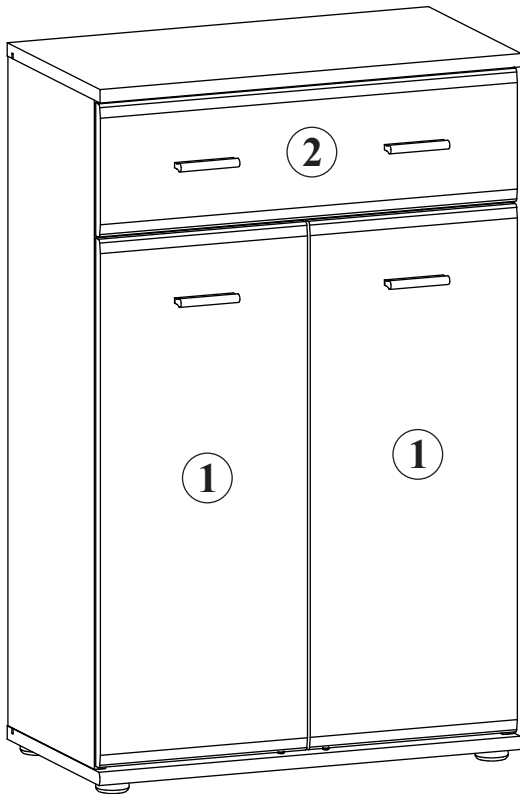
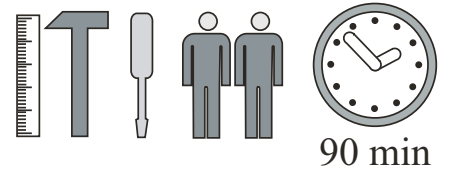

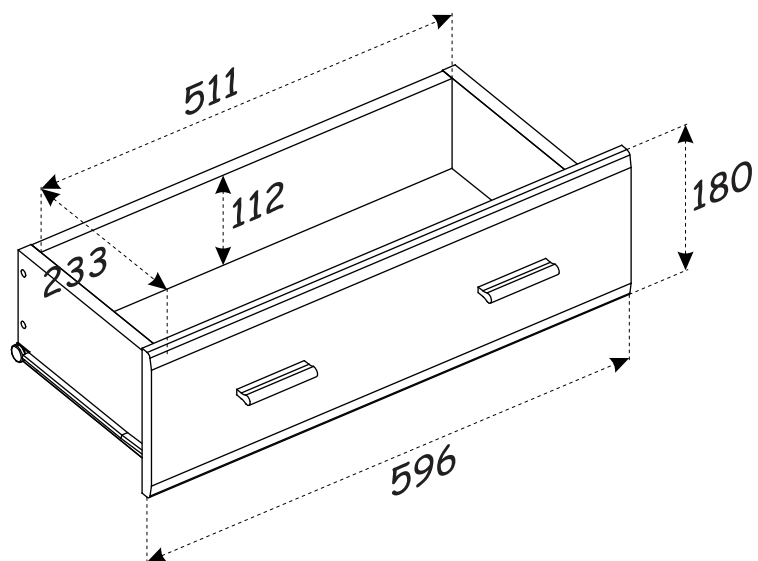
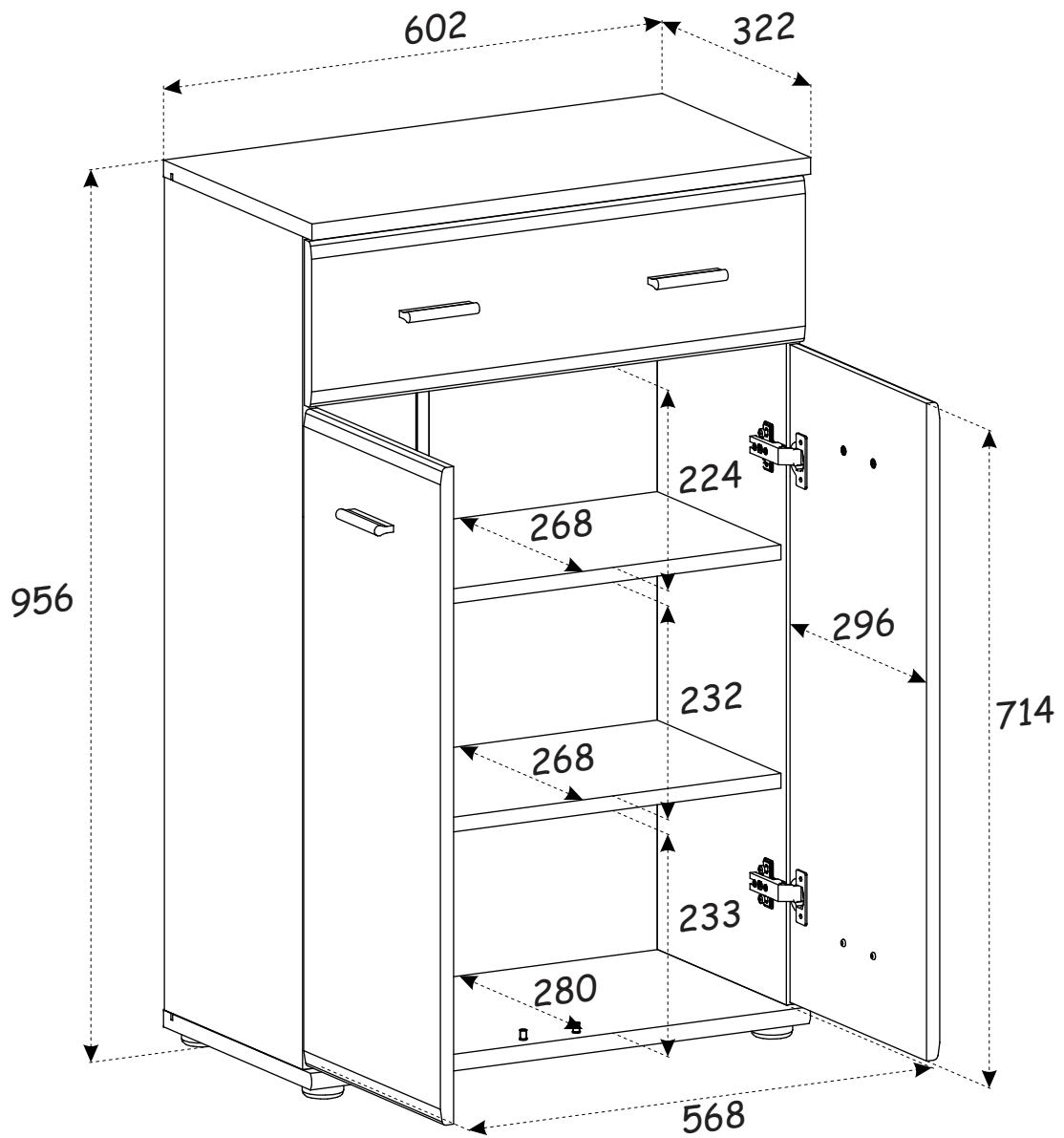



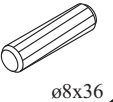
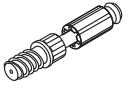
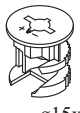

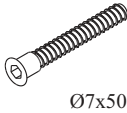

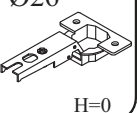
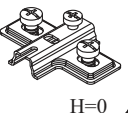
NO	Dim.			Col.-No	Qty
1	714	296	16	1	2
2	596	180	16	1	1
3	905	300	16	1	1
4	905	300	16	1	1
5	602	322	18	1	1
6	602	322	18	1	1
7	250	132	16	1	1
8	250	132	16	1	1
9	511	112	16	1	1
10	568	268	16	1	2
11	523	253	3	1	1
12	916	289	3	1	1
13	916	289	3	1	1

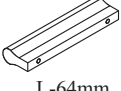

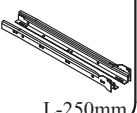
# ARMARIO 1 ECO TYP G

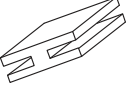
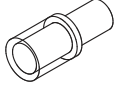
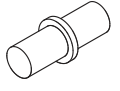
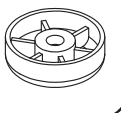

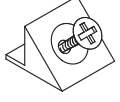
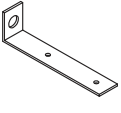
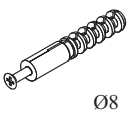

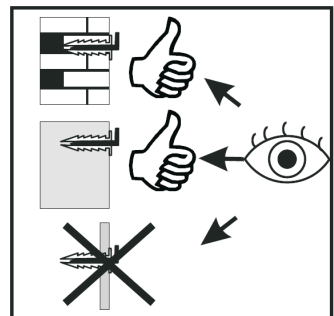
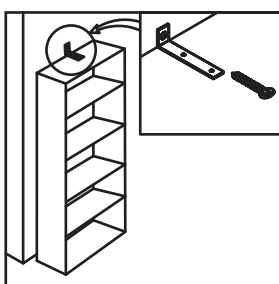
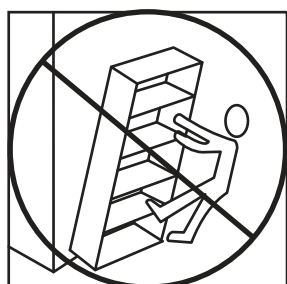
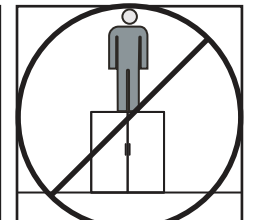
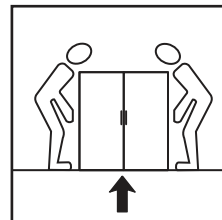
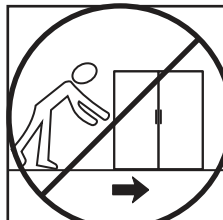
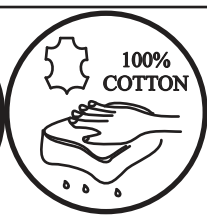
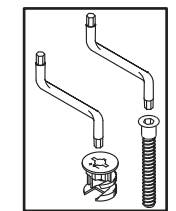
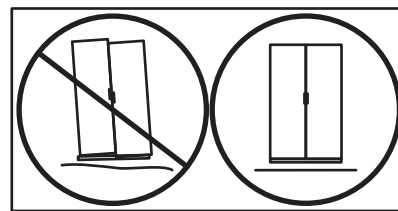
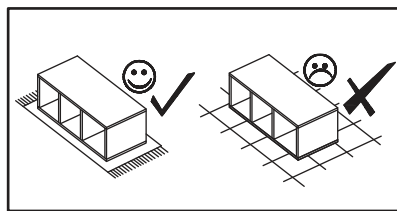
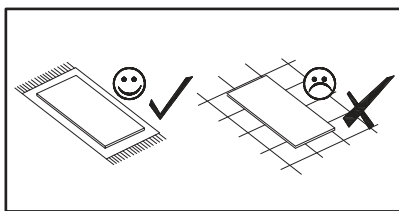
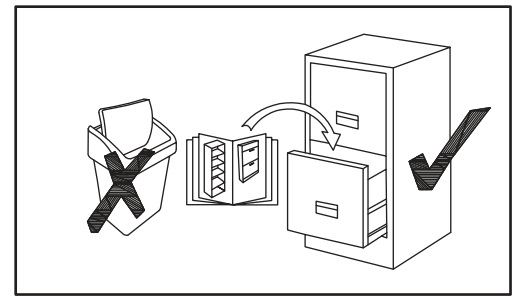
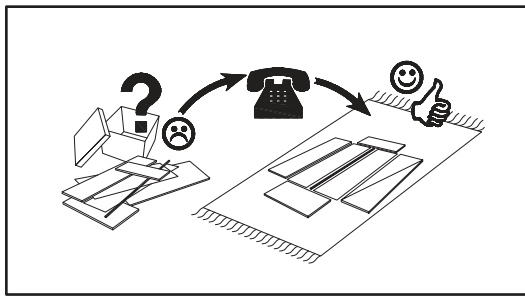
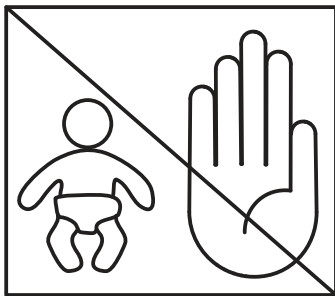
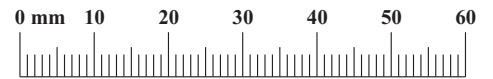

# ARMARIO 1 ECO TYP G

A1 x12  ø8x36	B4 x6 	B5 x6  ø15x12	G5 x6 	B11 x8  ø7x50	G4 x8 
E1 x4  H=0 Ø26	E2 x4  H=0	D10 x14  USØ3,5x13	KL x4  L-64mm	UP6 x8  UPØ4x30	Z2 x4  Ø5
H5 x1  L-250mm	D8 x4  ESØ5x13	UP13 x5  UPØ3x16	G8 x1 	G20 x2 	G7 x8 
I11 x4 	UP11 x4  UPØ4x20	S1 x12 	L1 x1 	KR1 x1  Ø8	G2 x1 

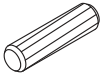

# ARMARIO 1 ECO TYP G

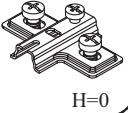
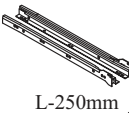
## 1

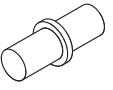
A1 x8	 ø8x36	B5 x4	 ø15x12	E2 x4	 H=0
H5 x1	 L-250mm	D8 x4	 ES05x13	G7 x8	

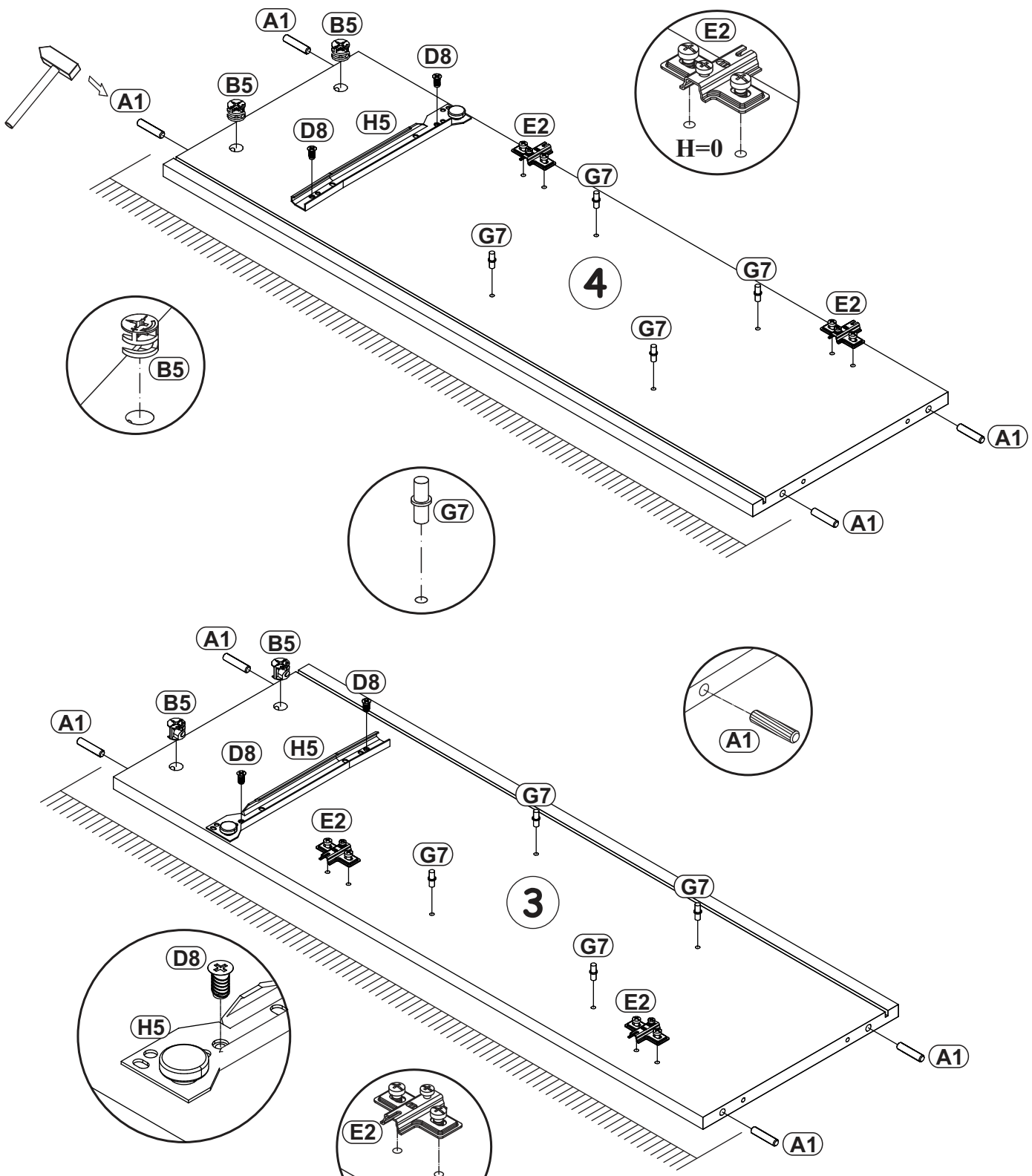
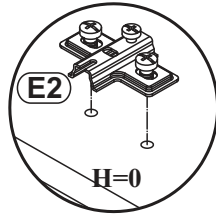
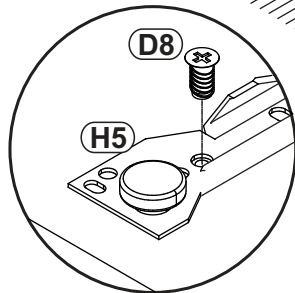
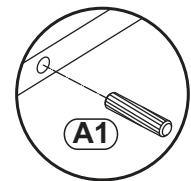
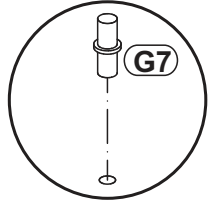
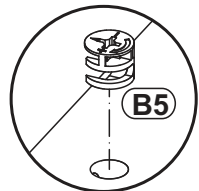
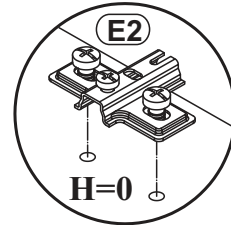
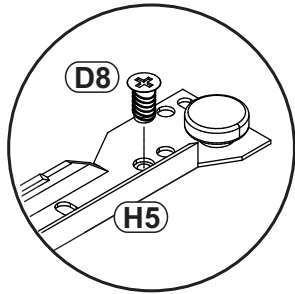

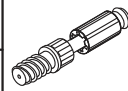

2

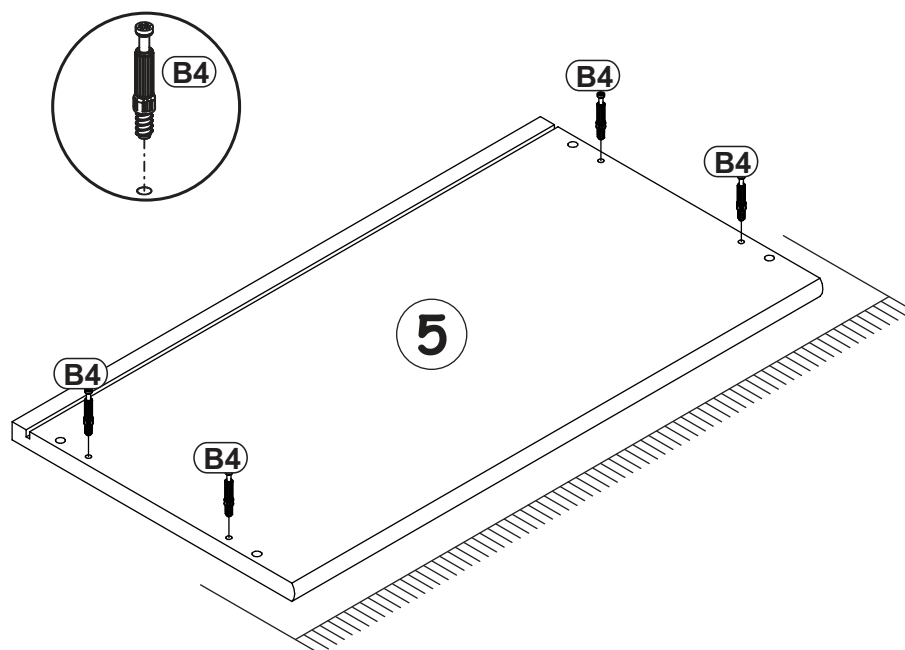
B4	
x4	

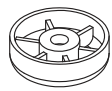

3

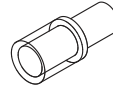
I11		UP11		G20	
x4		x4	UPØ4x20	x2	

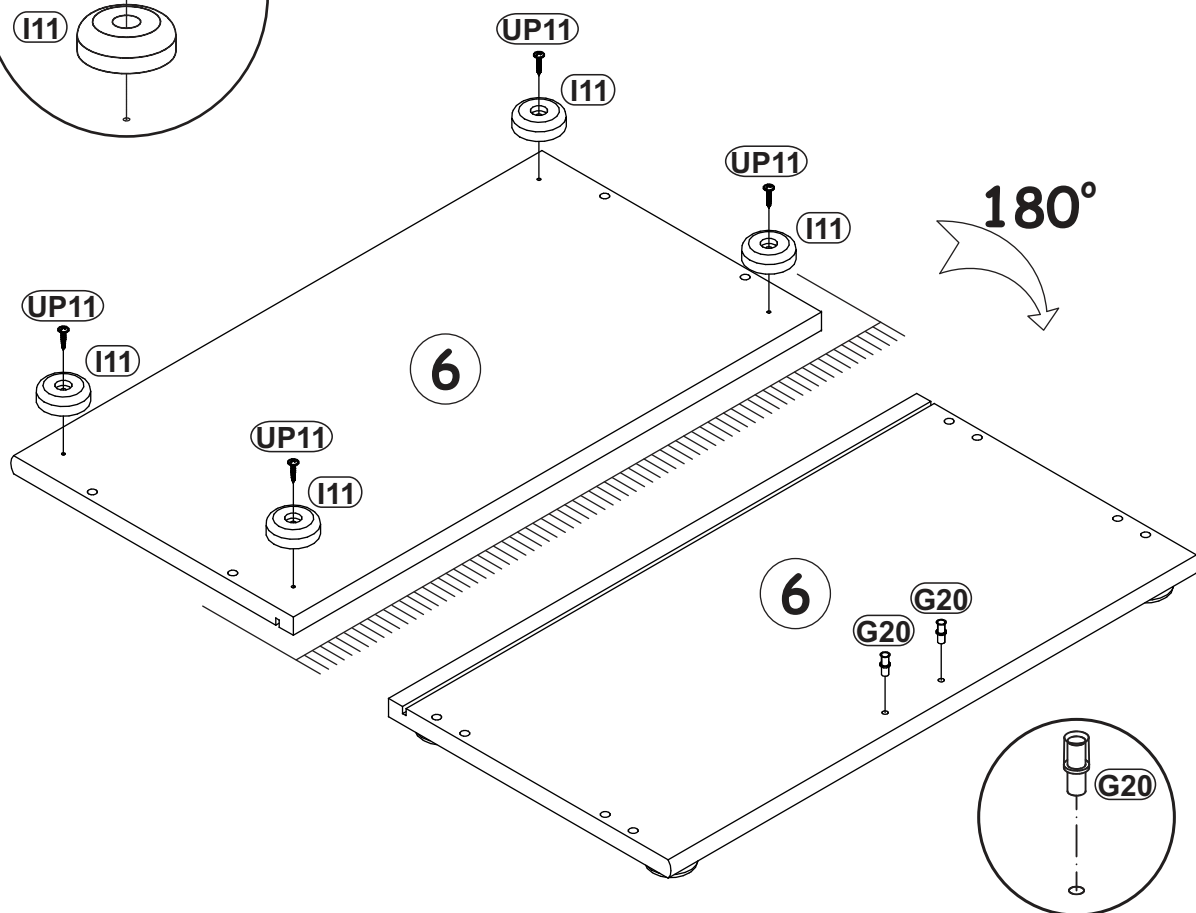
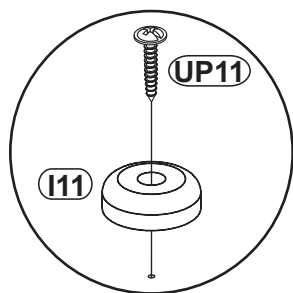

4

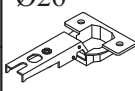
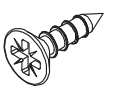
E1	Ø26	D10	
x4	 H=0	x8	 USØ3,5x13

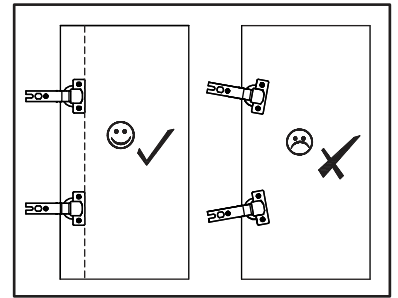
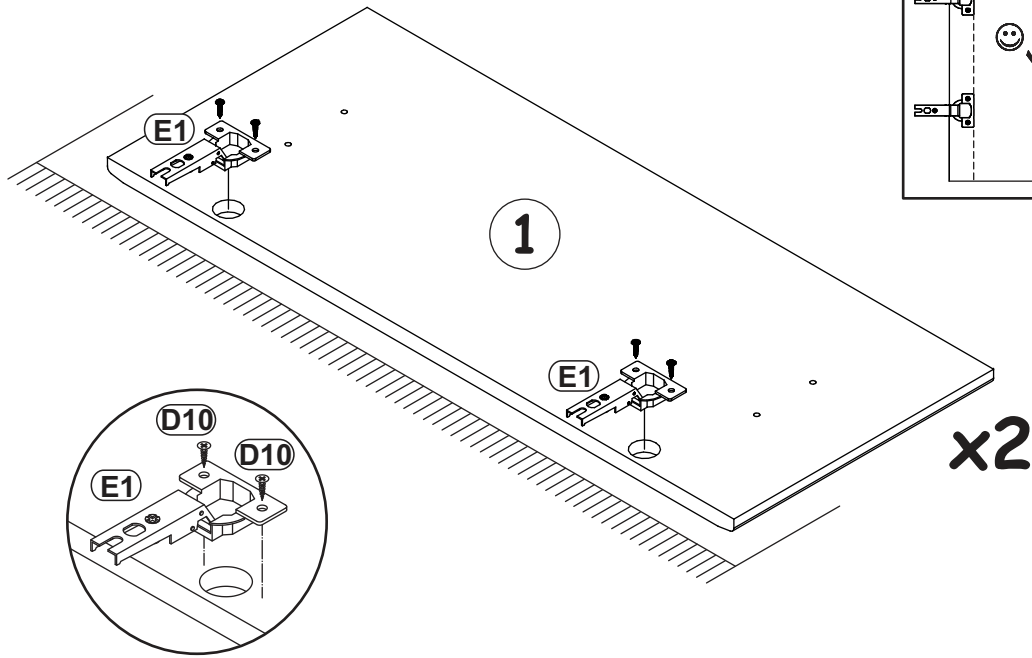

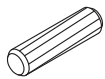
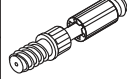
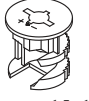

5

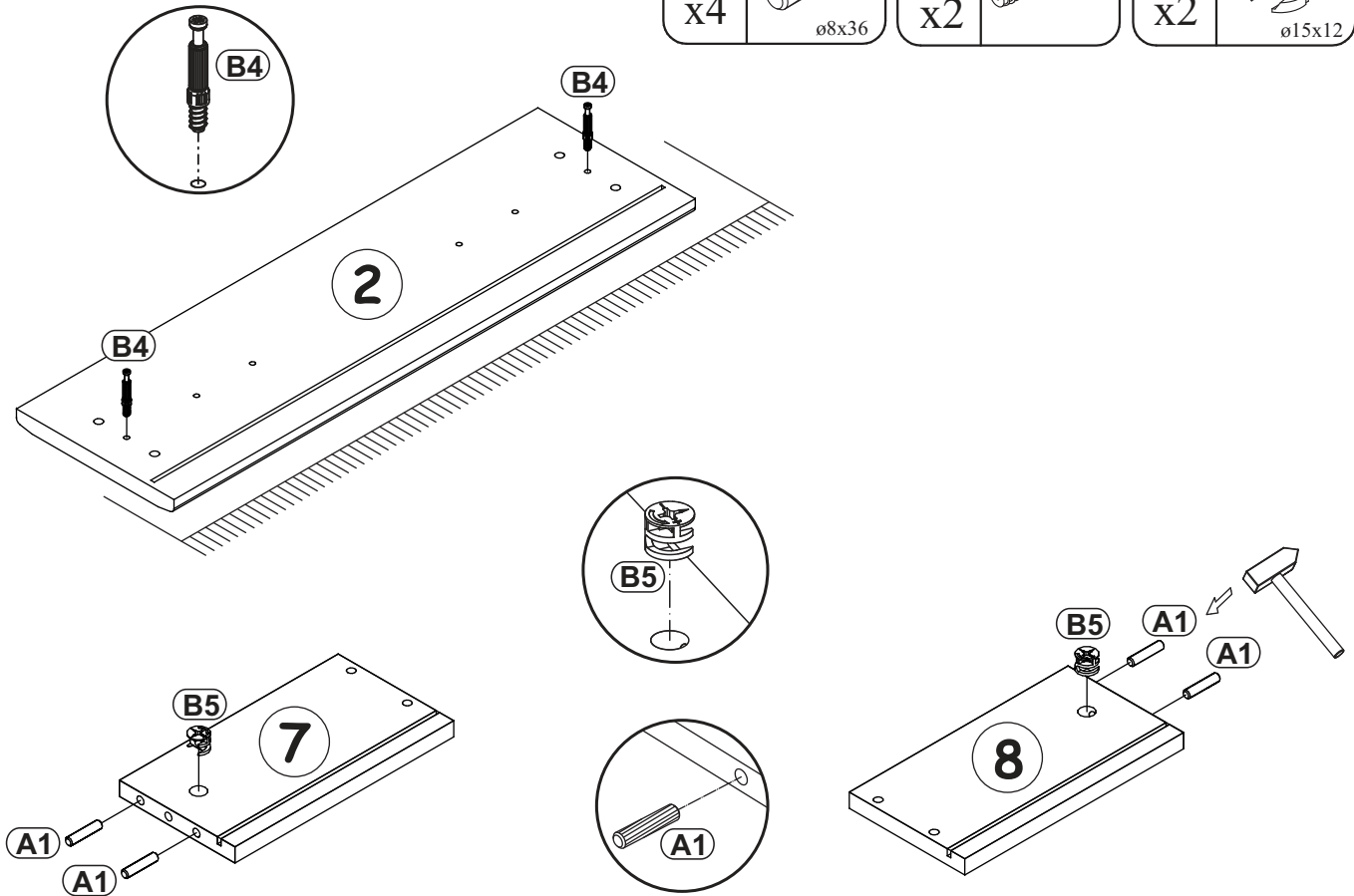
A1	B4	B5	
x4	 ø8x36	x2	
		x2	 ø15x12



6

B11		G4	
x4	Ø7x50	x4	

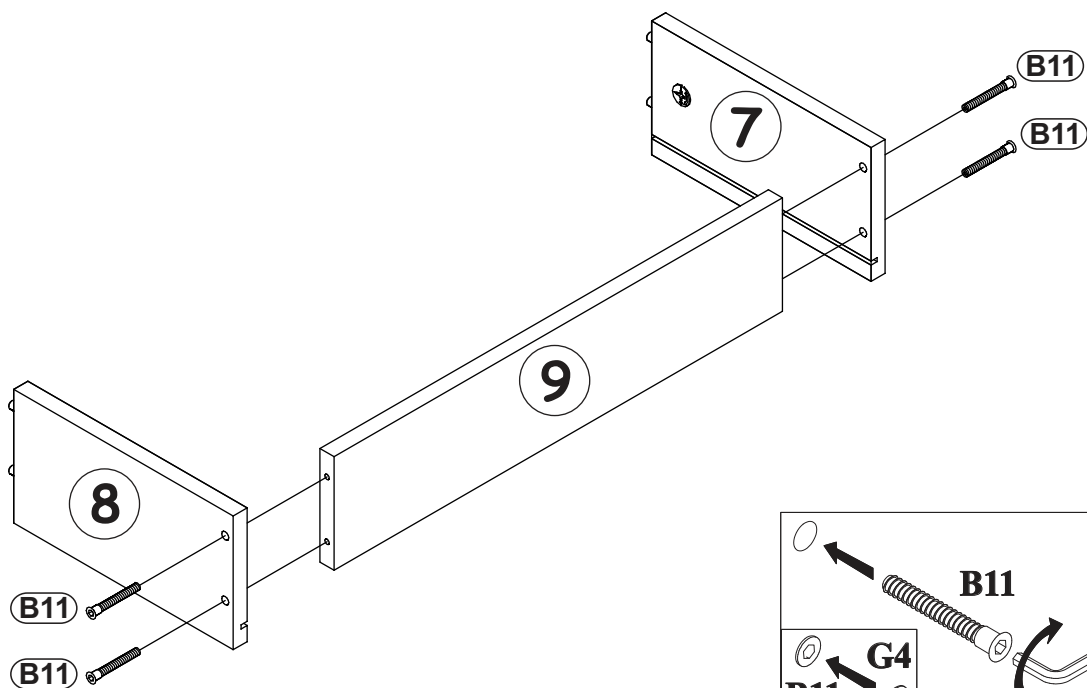

7

G5	
x2	

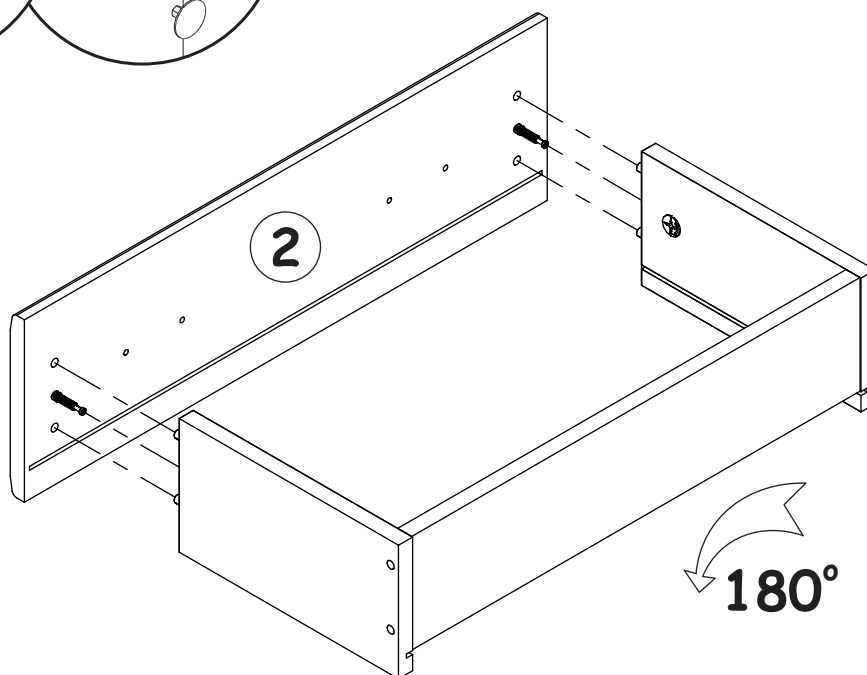
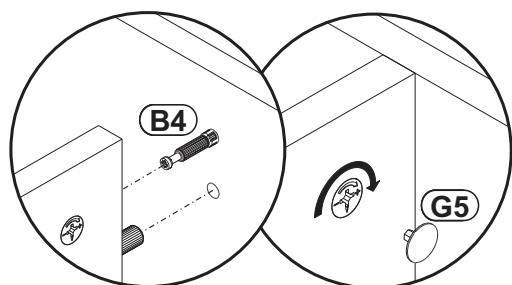

8

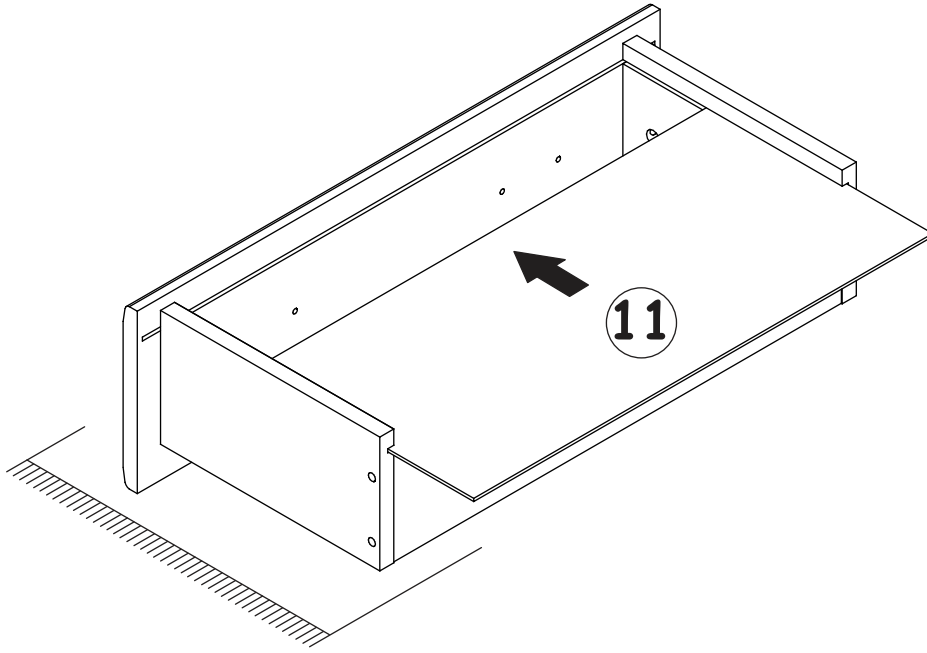

9

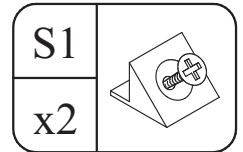
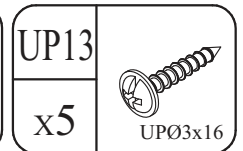
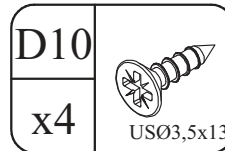
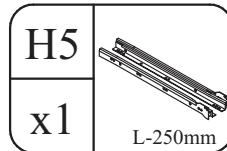

X=Y  $90^\circ$

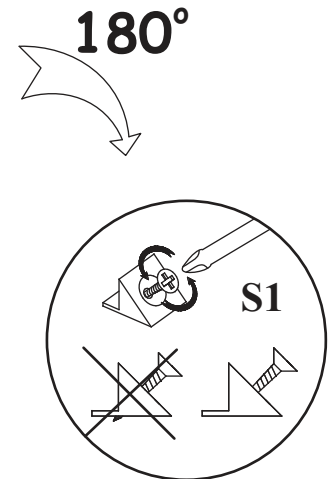
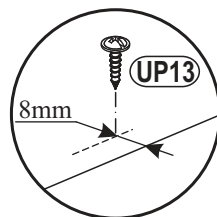
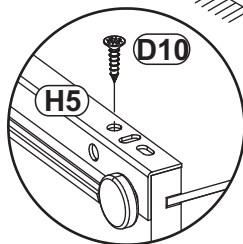
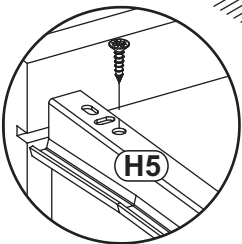
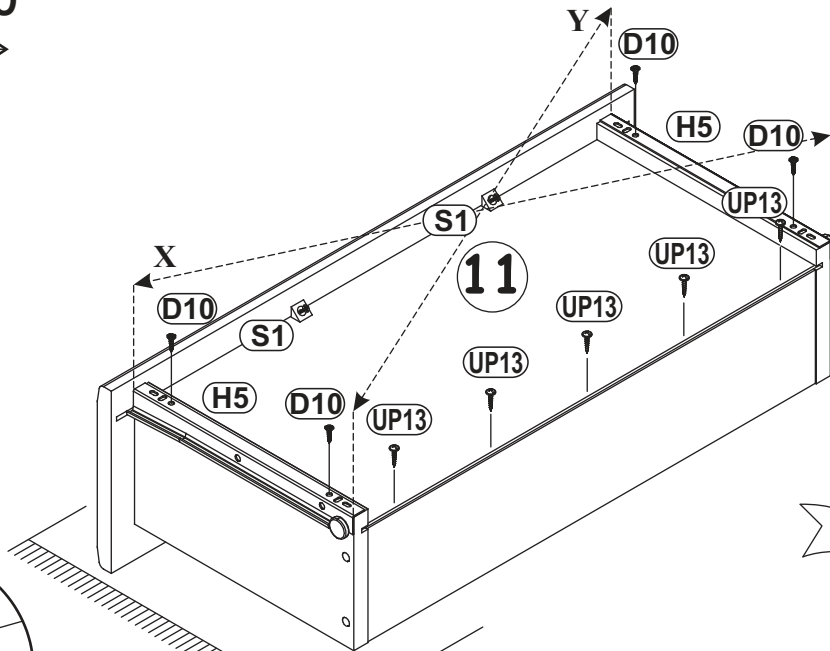



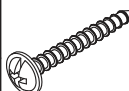

10

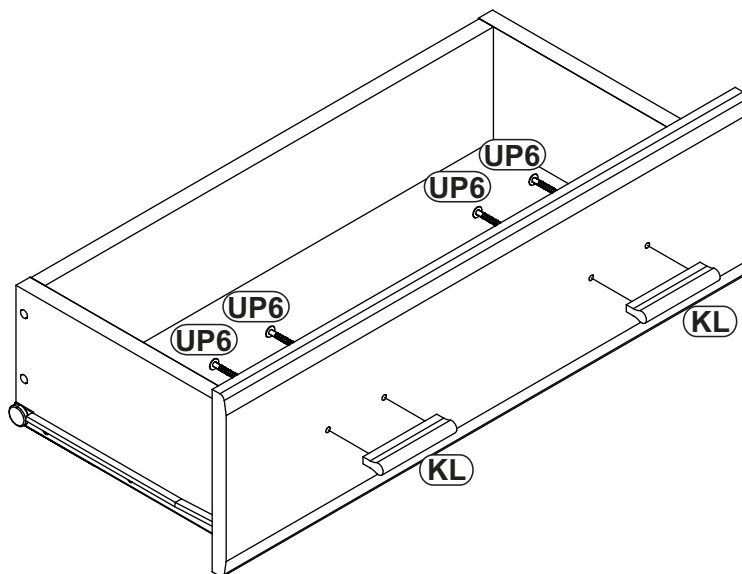
KL		UP6	
x2	L-64mm	x4	UPØ4x30



11

B11		G4	
x4	Ø7x50	x4	

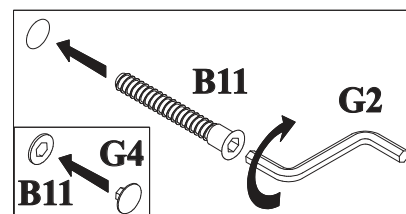
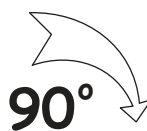
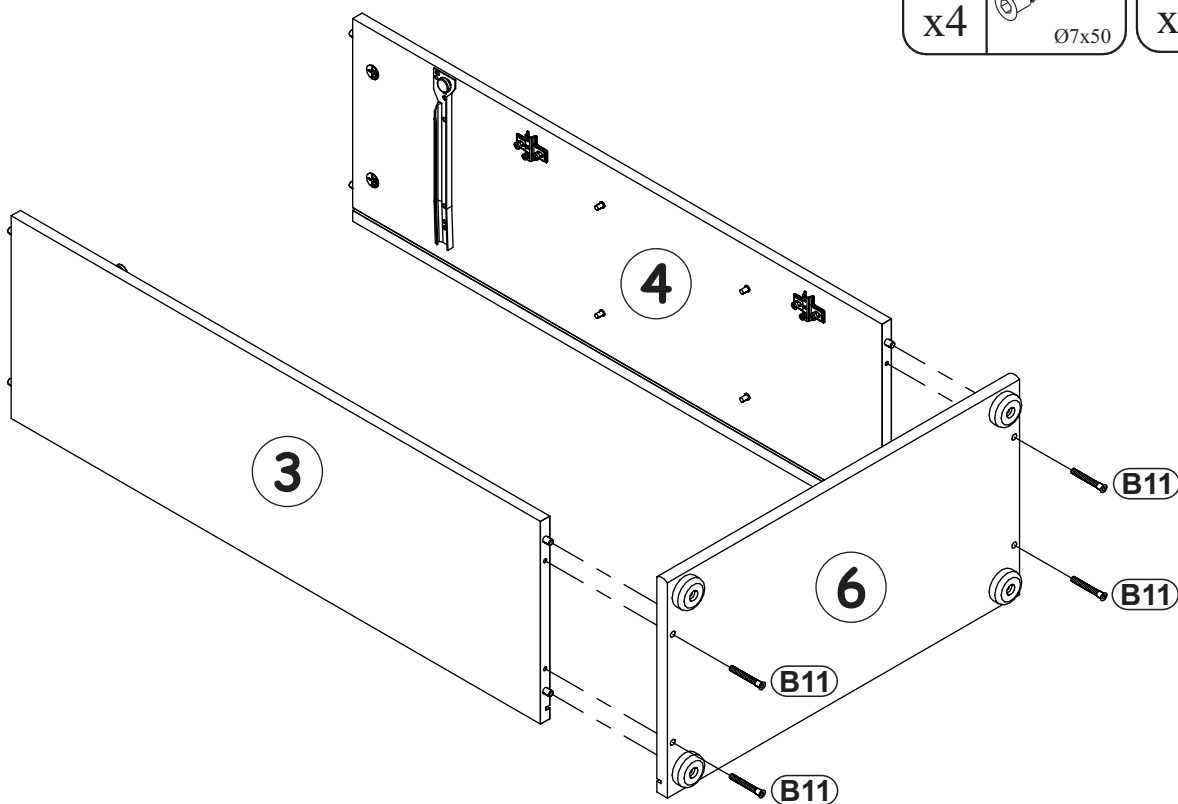

12

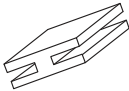
G8	
x1	

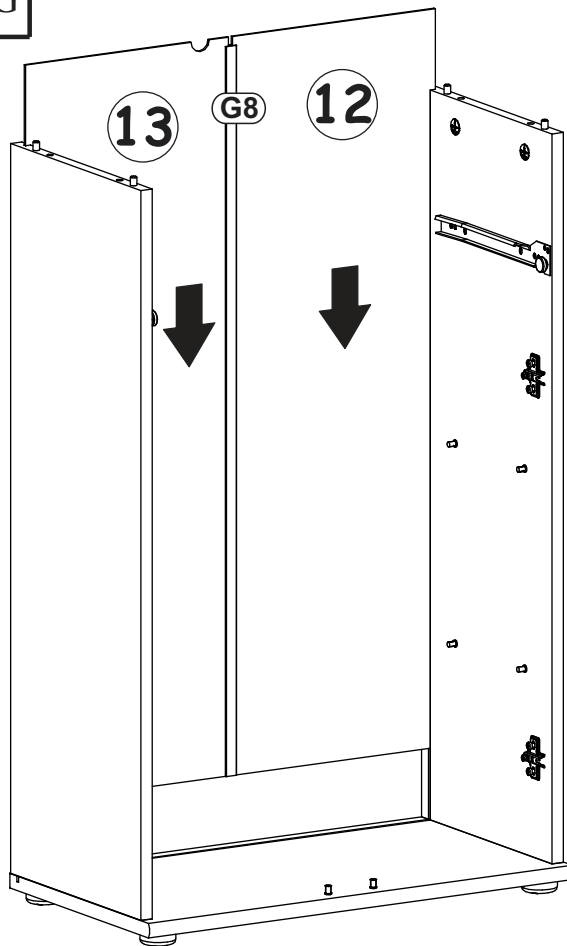

13

G5	
x4	

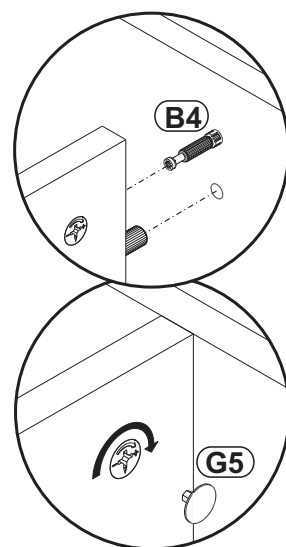
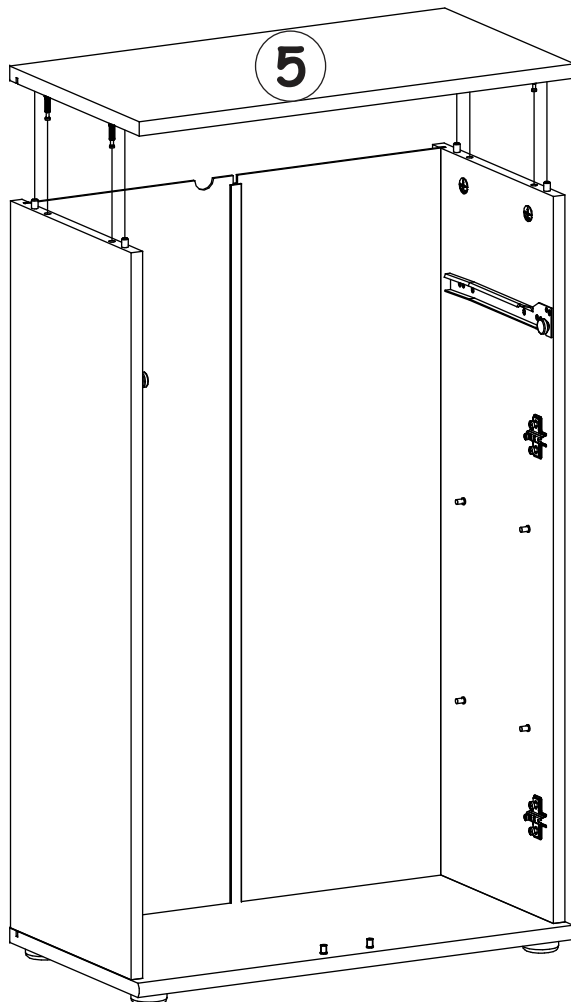

14

$X=Y$   $90^\circ$

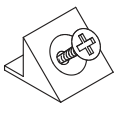
S1	
x10	

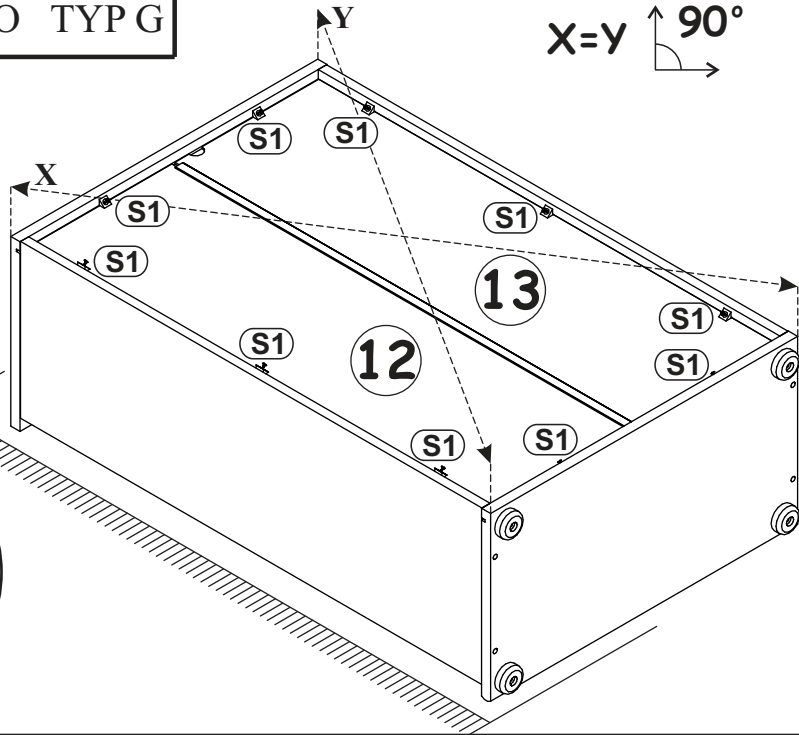
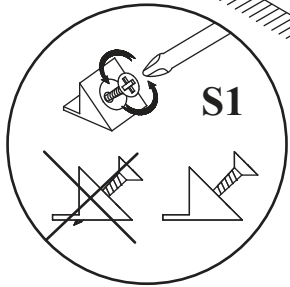

15

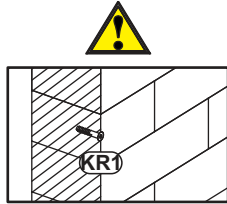
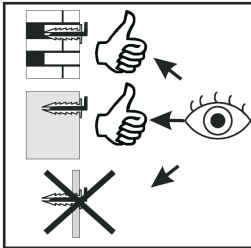

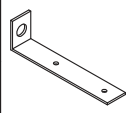
L1	
x1	

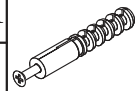
KR1	
x1	$\phi 8$

D10	
x2	USØ3,5x13

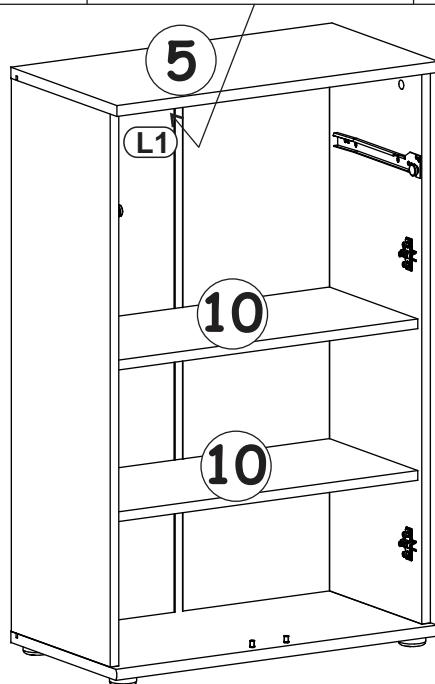
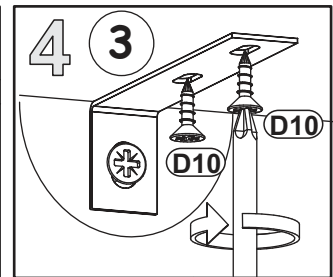
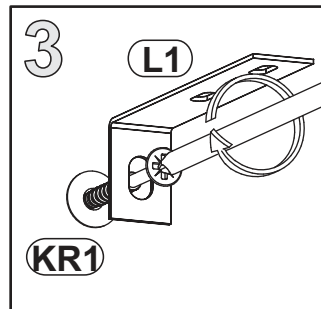
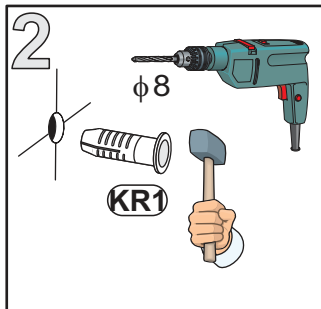
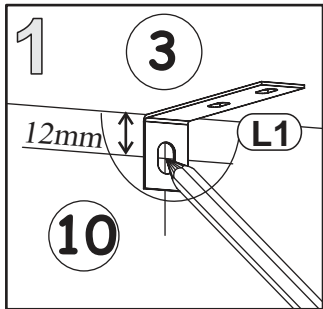

16

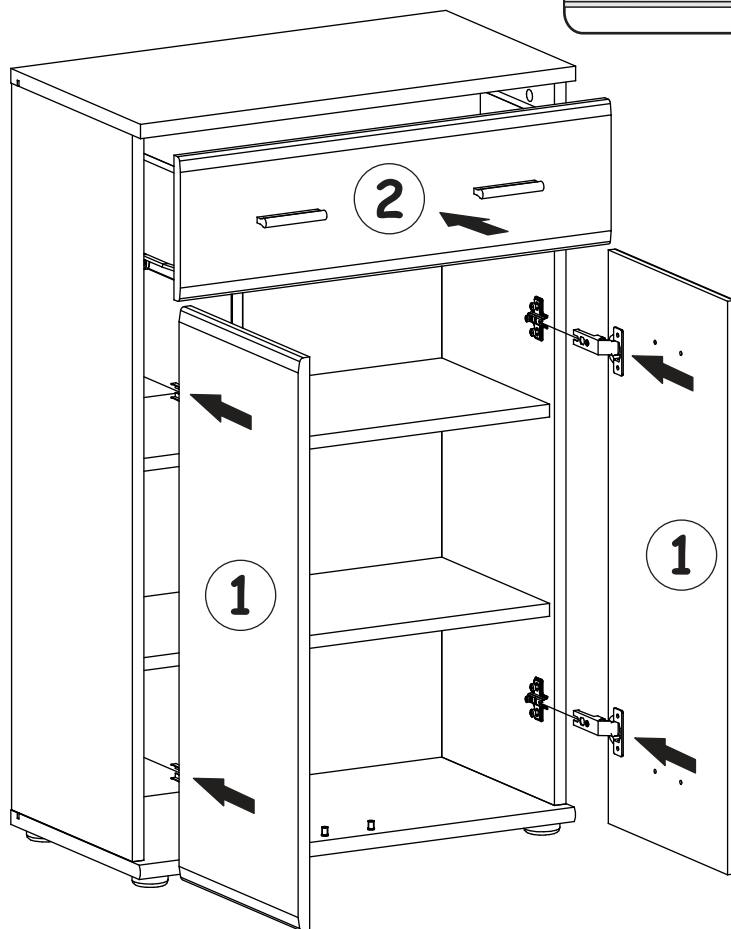
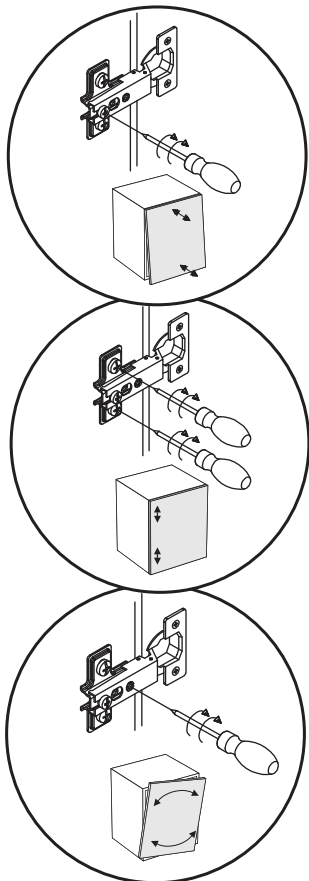

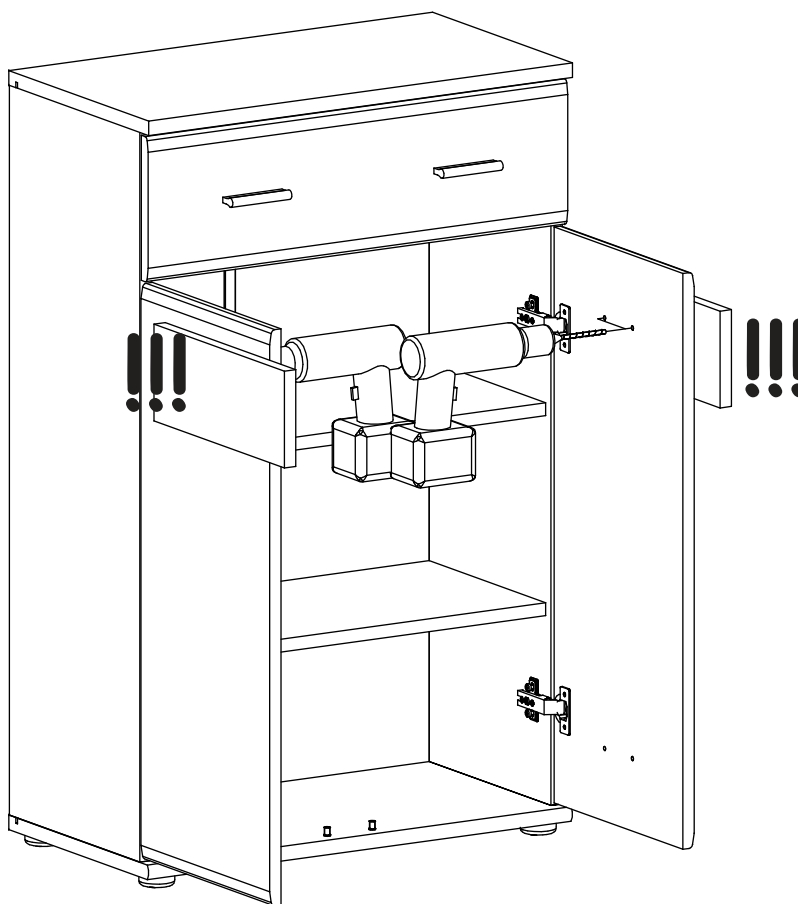

17

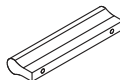

18

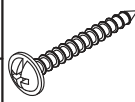
KL	
x2	L-64mm

UP6	
x4	UP04x30

Z2	
x4	Ø5

