

NO	Dim			Col.-No	Qty
1	1200	200	16	1	1
2	1198	180	16	1	1
3	600	200	16	1	1
4	598	180	16	1	1

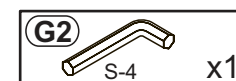

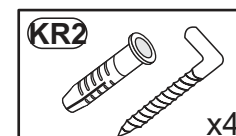

## 1

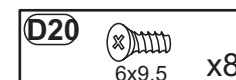
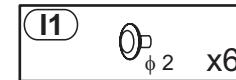
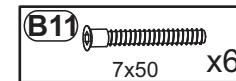
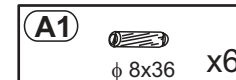
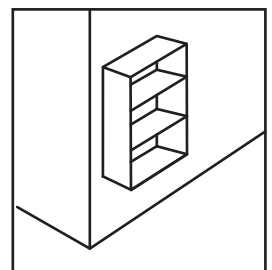
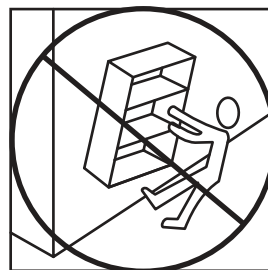
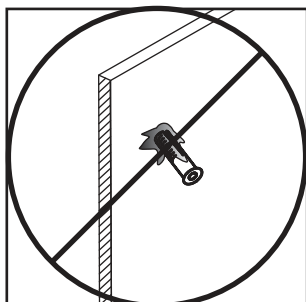
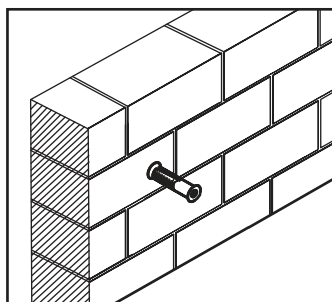
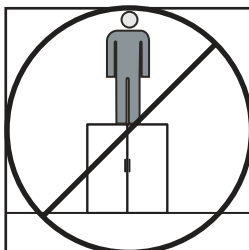
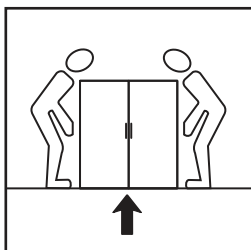
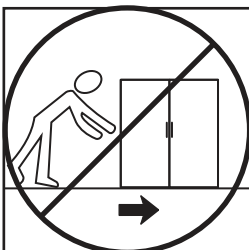
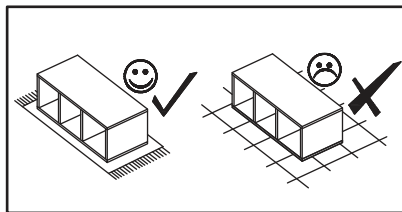
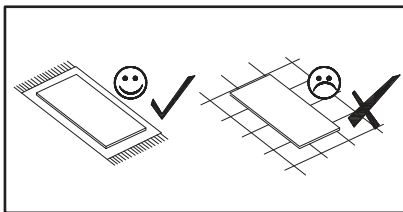
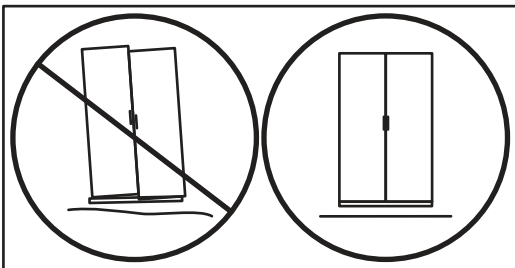
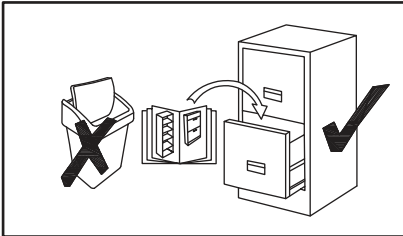
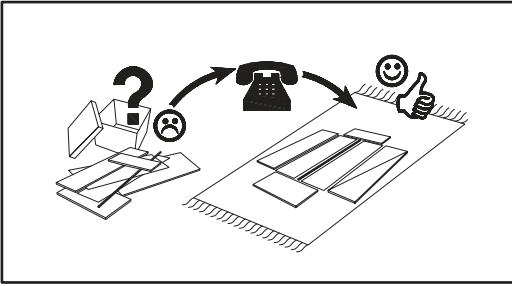
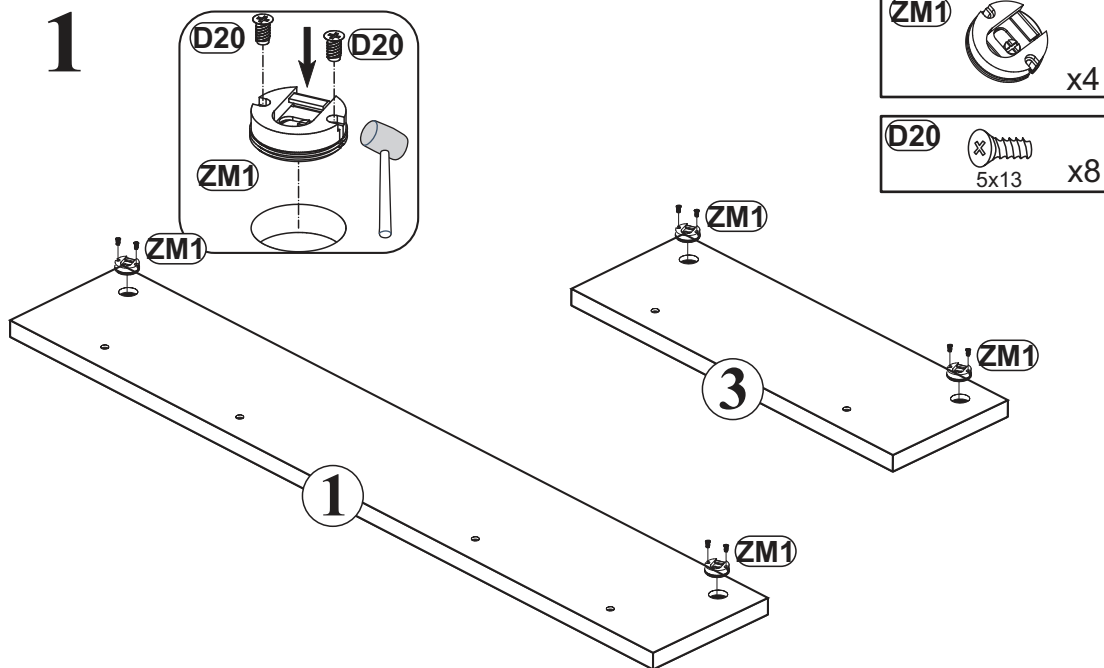

## 2

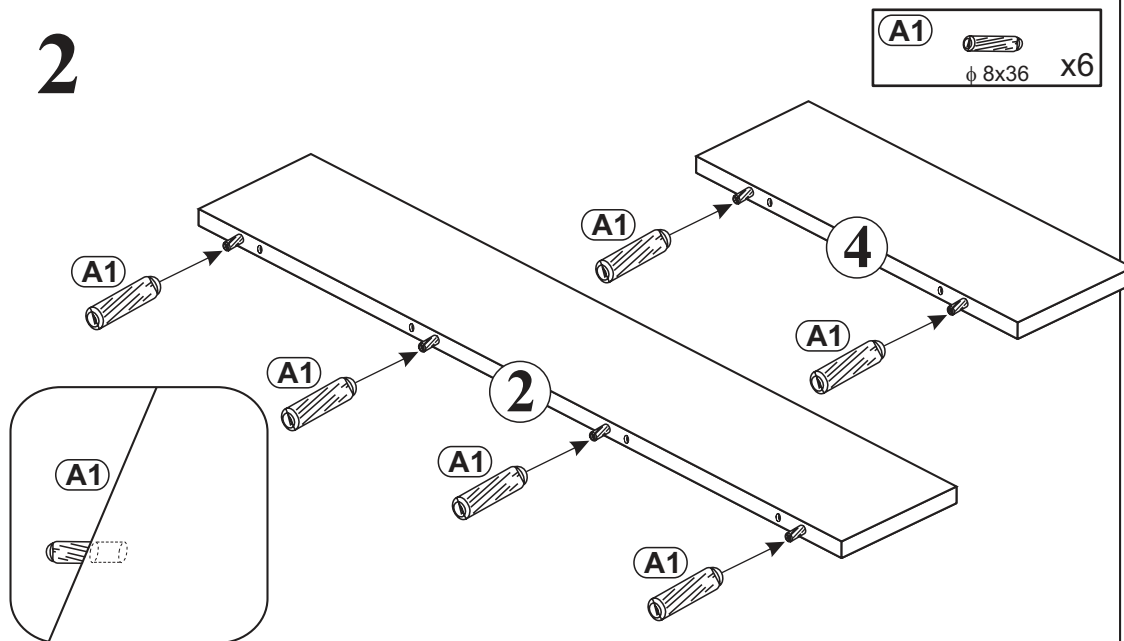

## 3

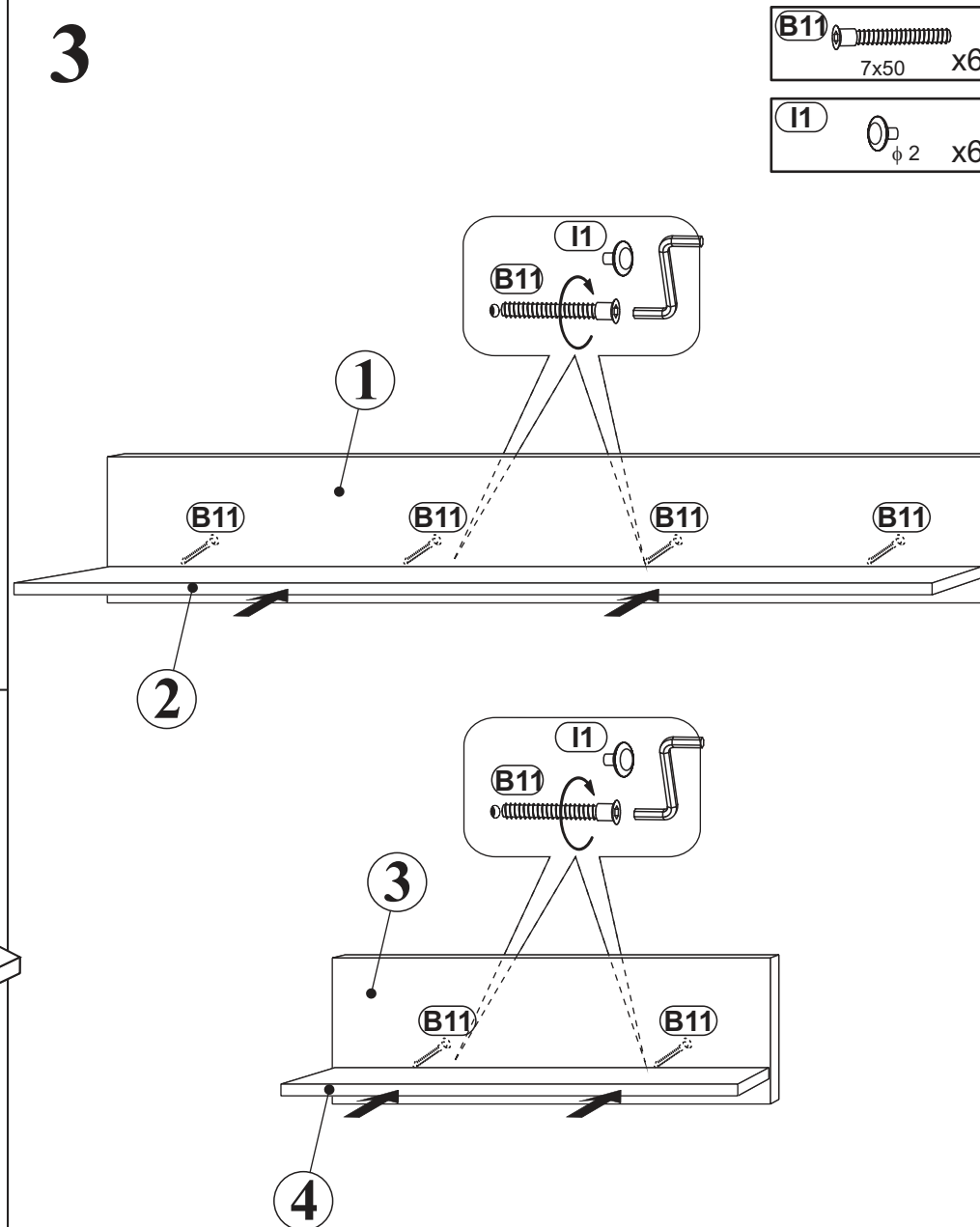

4

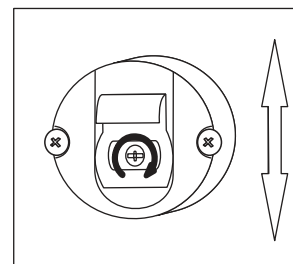
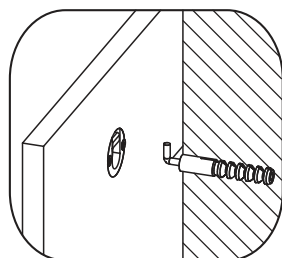
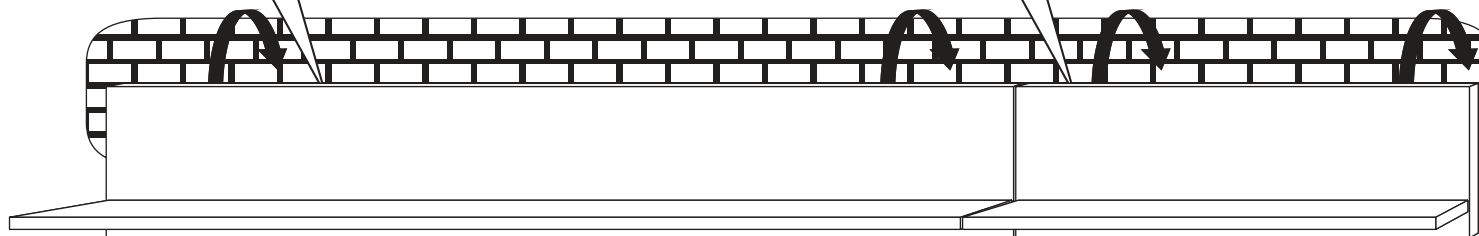
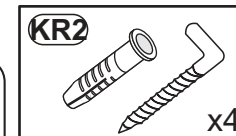
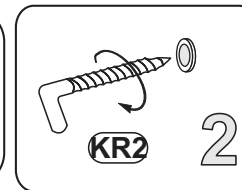
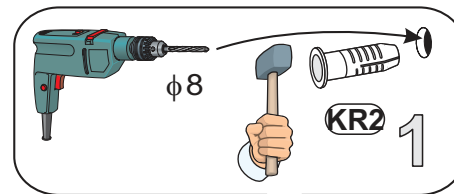
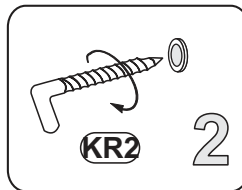
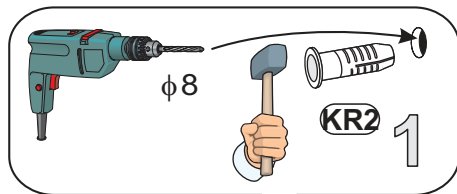

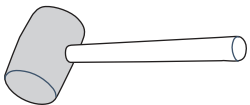
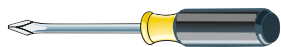
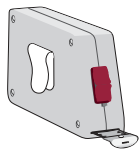
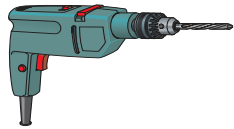
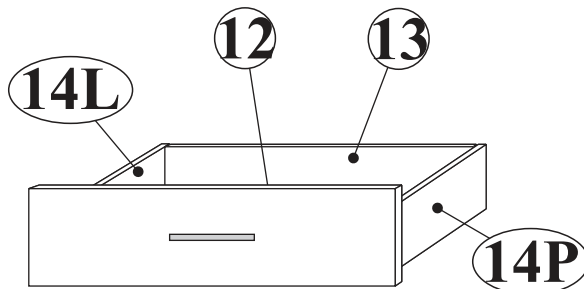
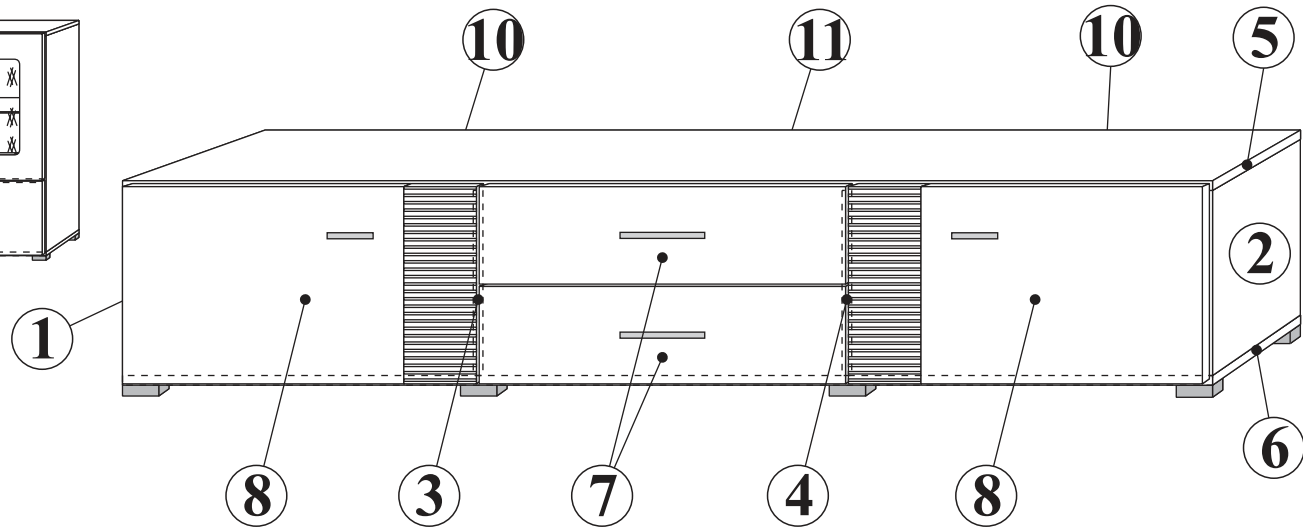
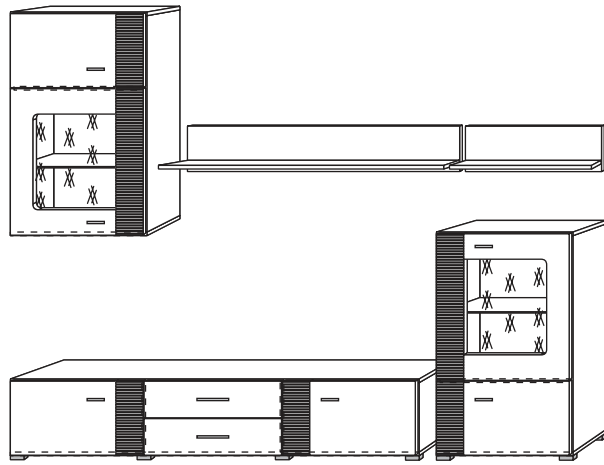
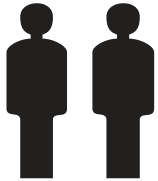

NO	Dim		Col.-No	Qty
1	298	400	16	1
2	298	400	16	1
3	298	380	16	1
4	298	380	16	1
5	1802	400	16	1
6	1802	400	16	1
10	589	309	3	2
11	600	309	3	1
8	596	326	16	2
7	596	161	25	2
14L	350	100	12	1
14P	350	100	12	1
13	551	86	16	2
12	561	353	3	2

ALLEPO

TYP 30

24 \_\_ \_AL

2/7

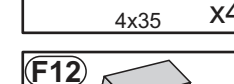
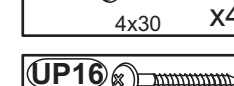
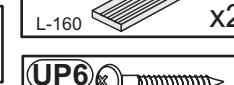
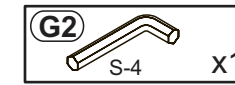
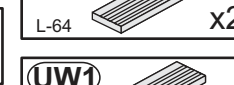
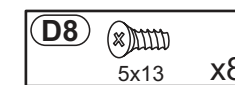
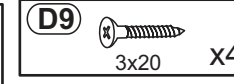
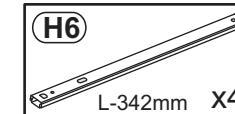
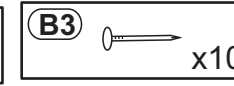
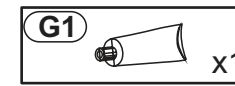
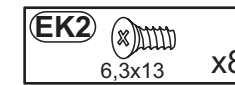
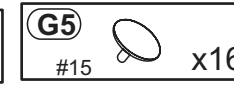
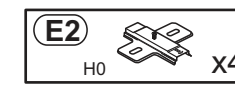
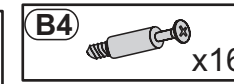
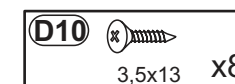
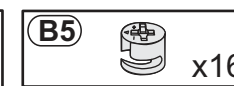
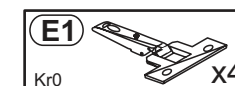
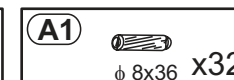
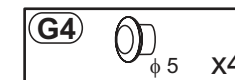
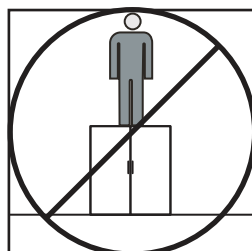
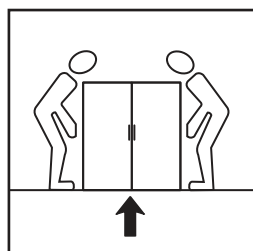
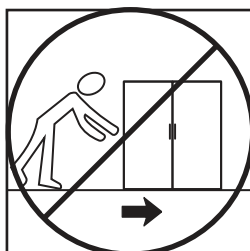
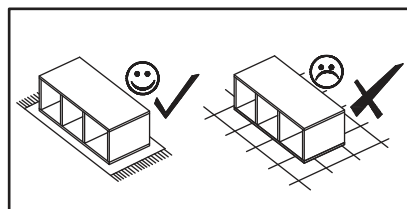
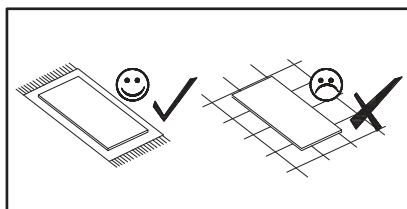
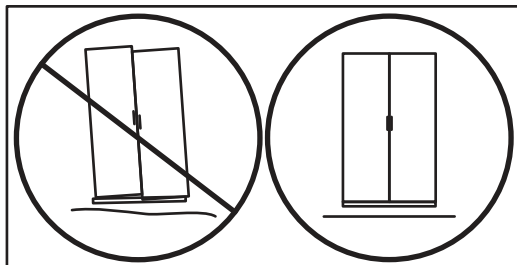
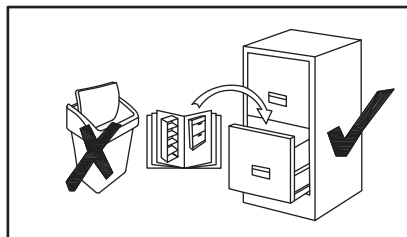
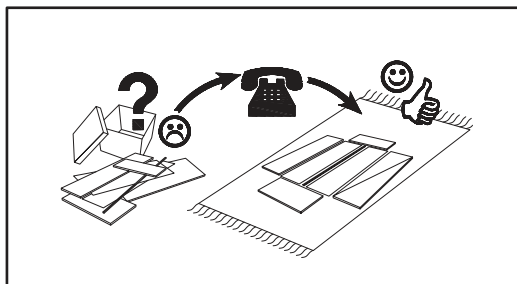

# 1

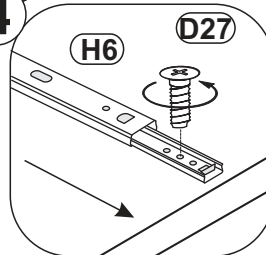
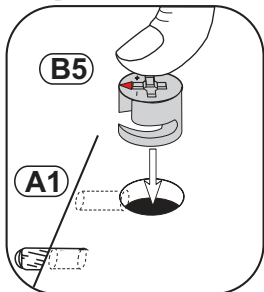
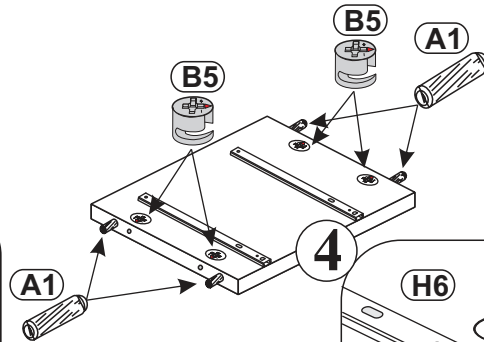
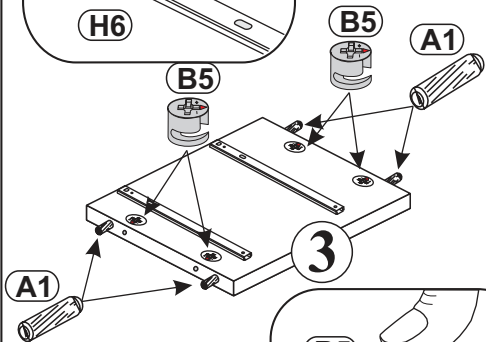
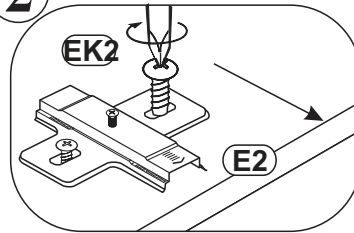
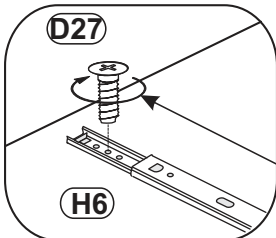
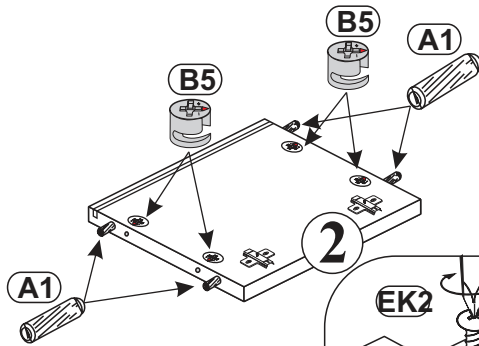
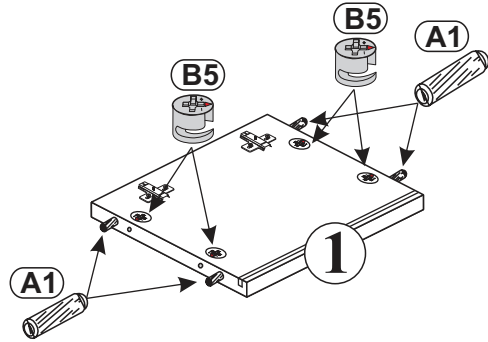
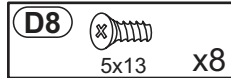
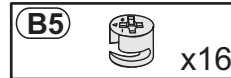
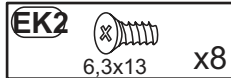
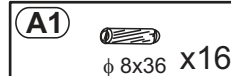
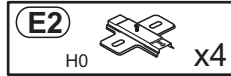
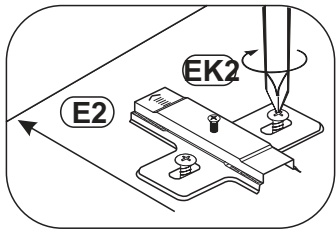

# 2

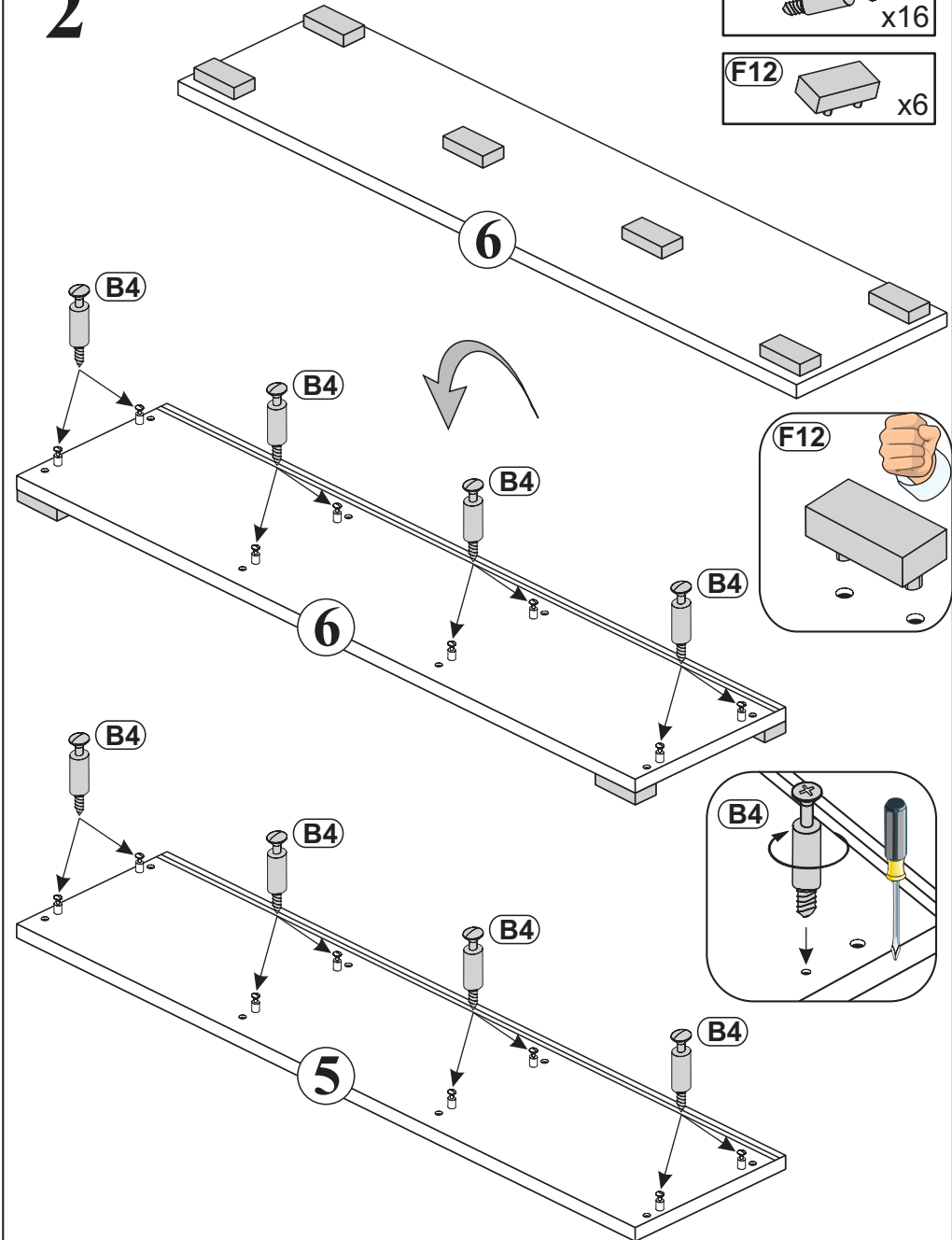
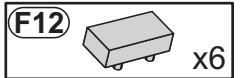
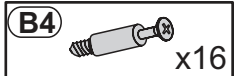

### 3

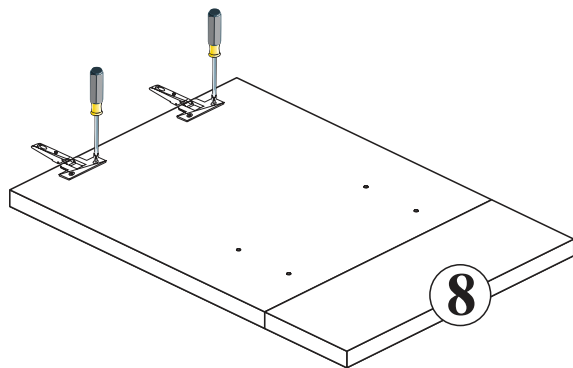
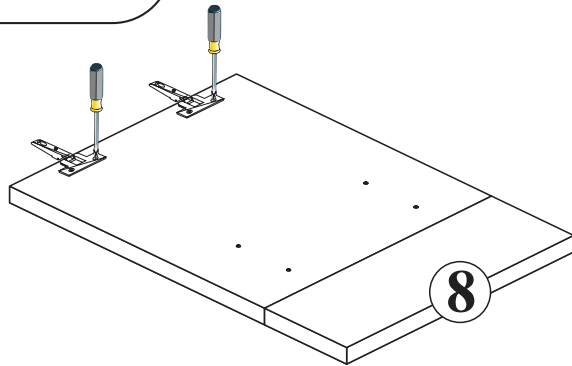
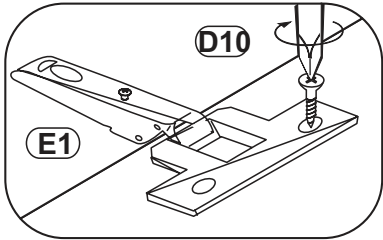
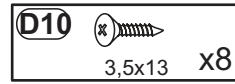
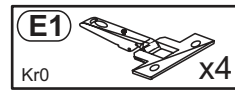

### 4

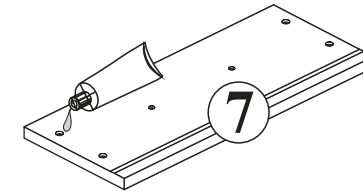
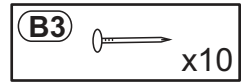
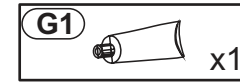
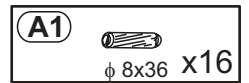
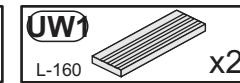
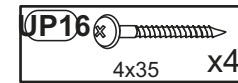

x2

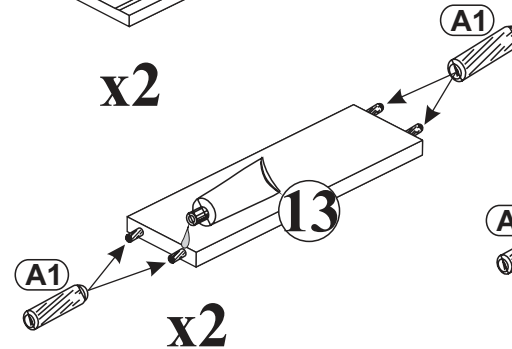

x2

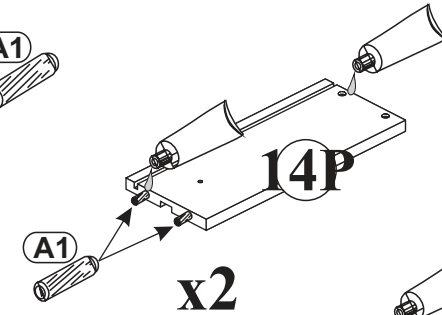

x2

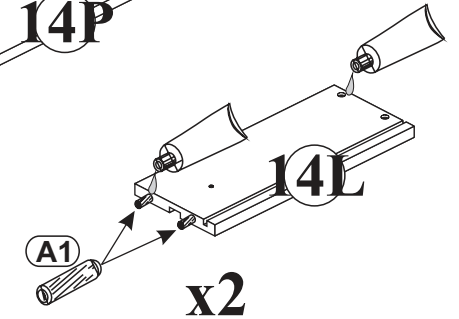

x2

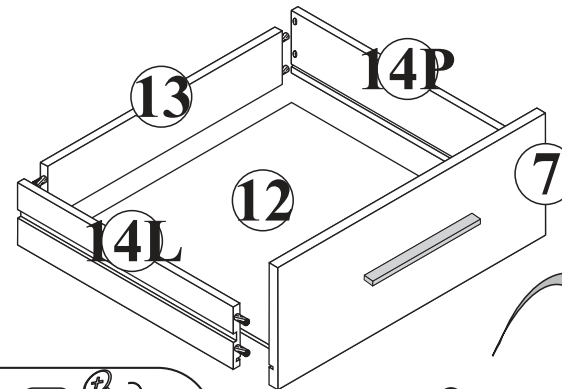

x2

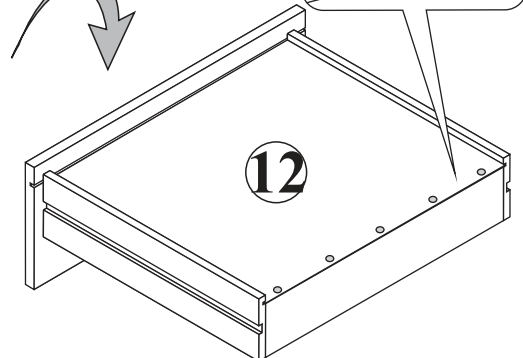
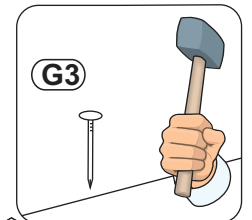
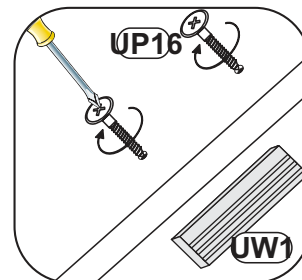



5

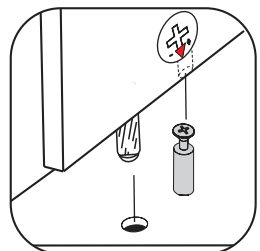
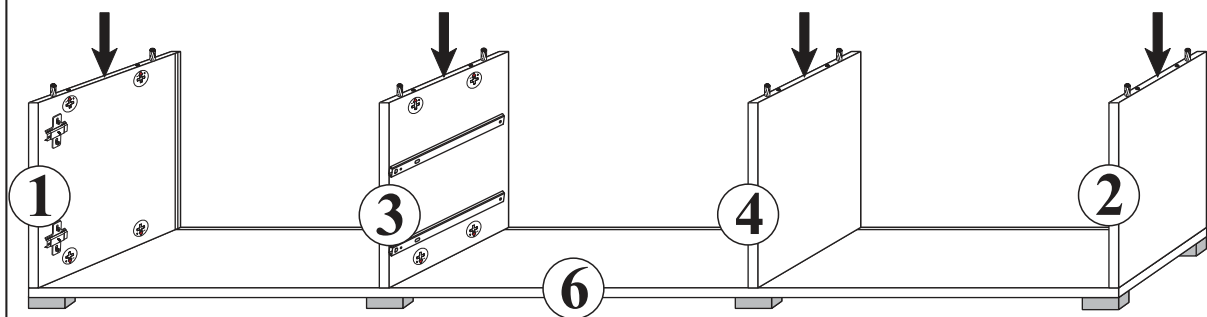

6

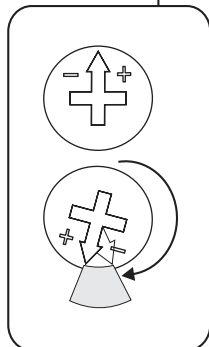
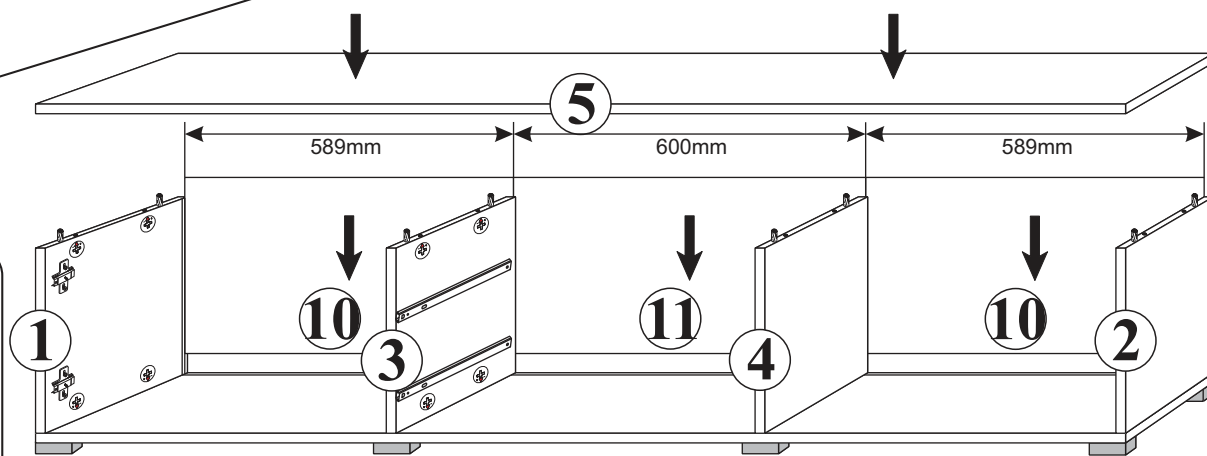
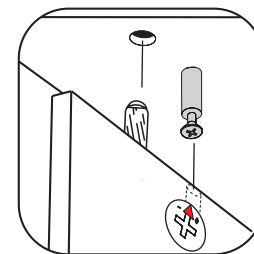

7

a=b

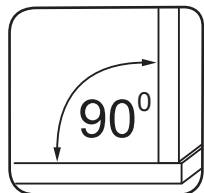
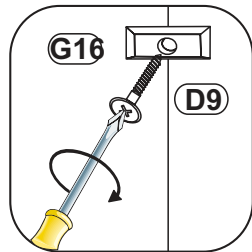
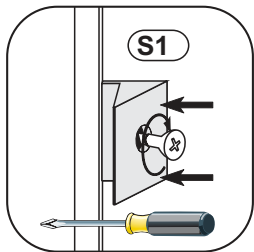
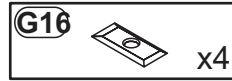
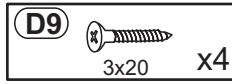
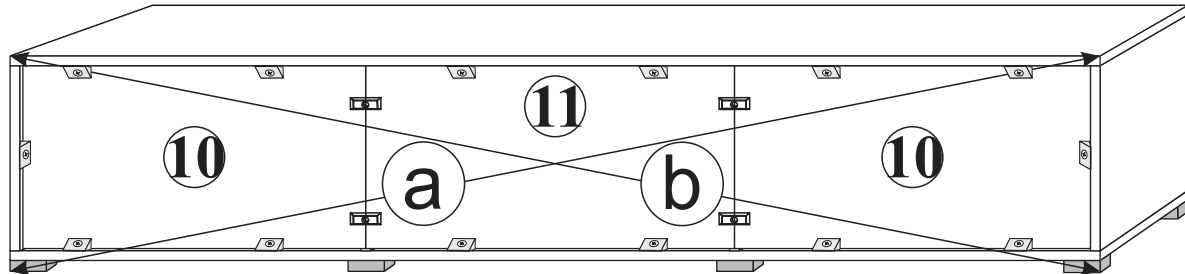

8

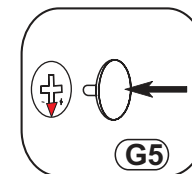
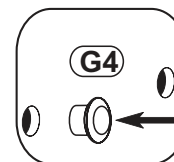
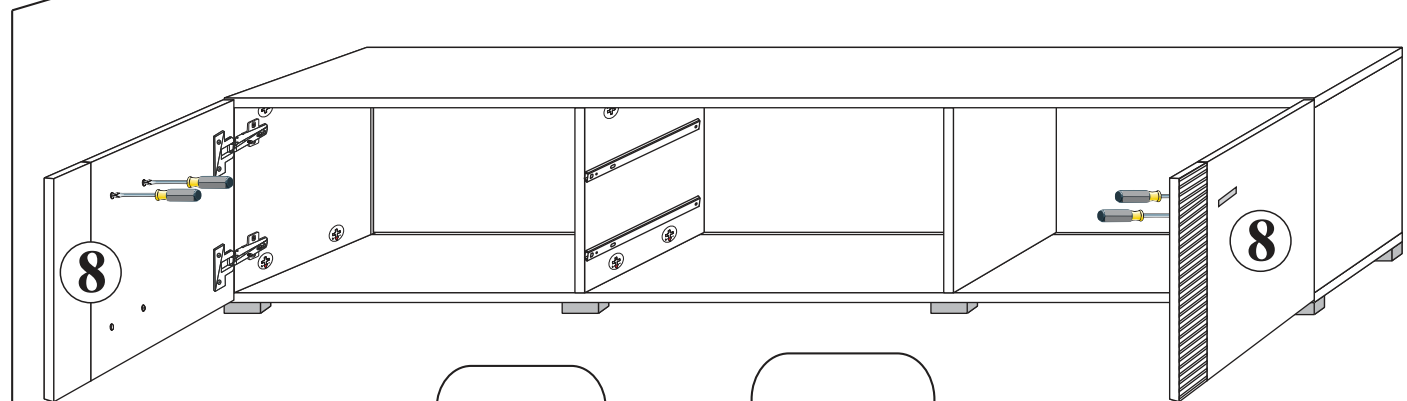
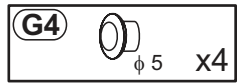
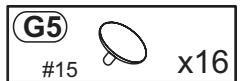
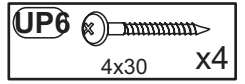
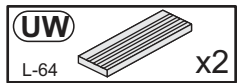
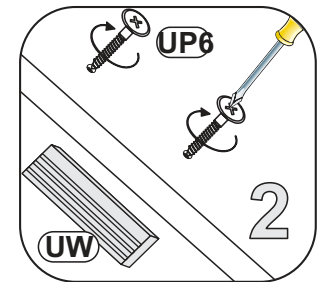
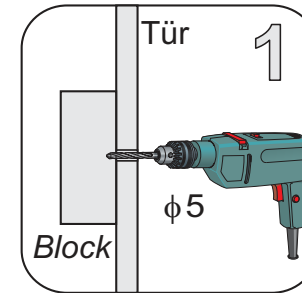
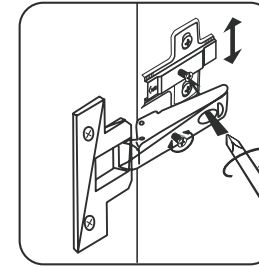

9

D18  
M4x9mm x4

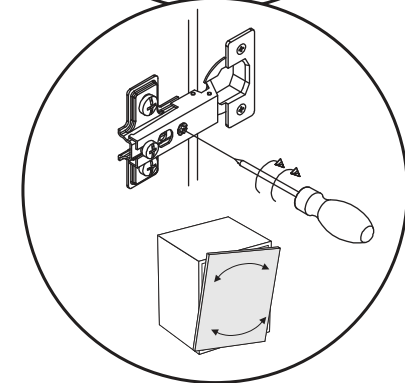
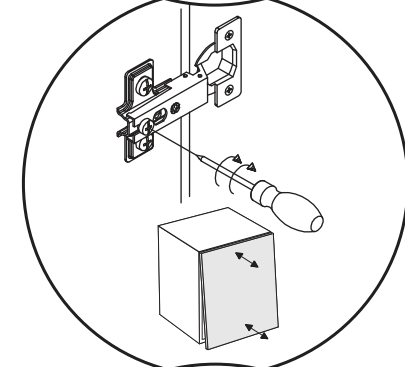
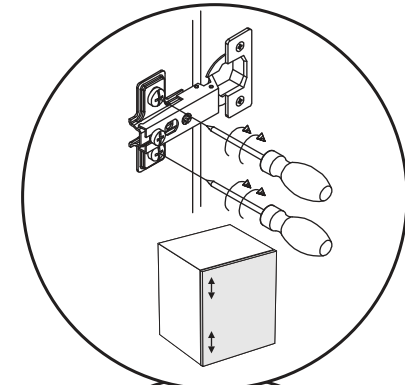
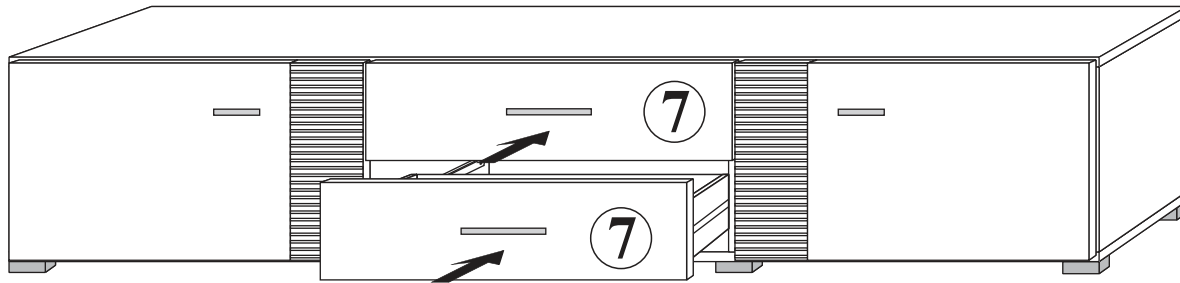
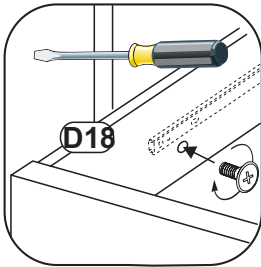

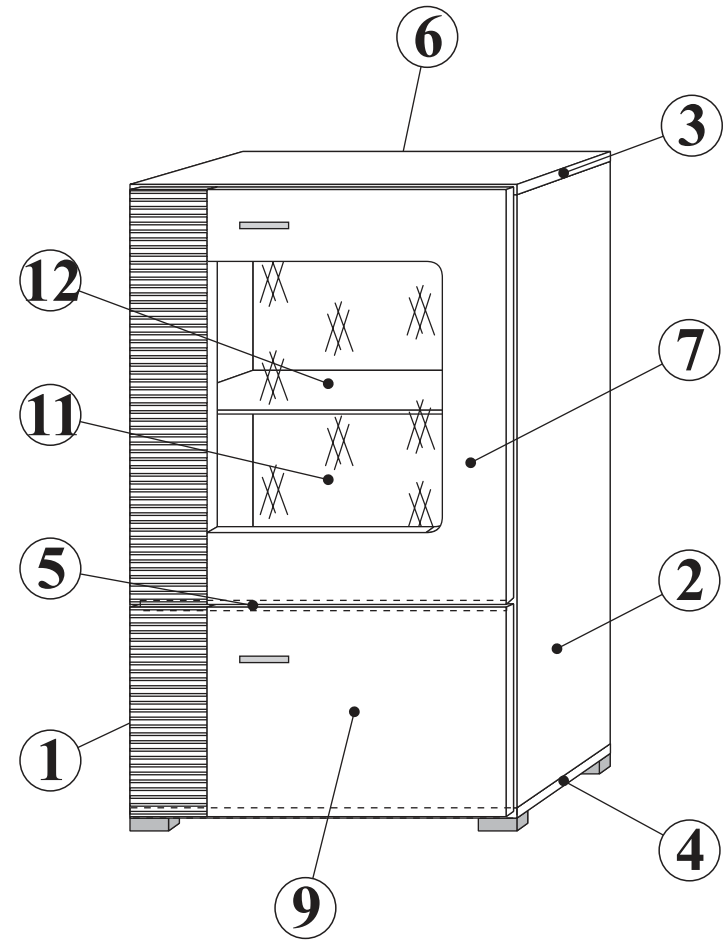
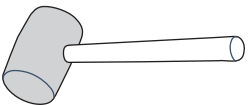
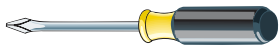
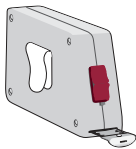
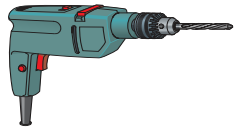
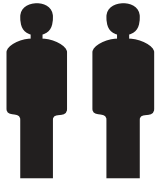
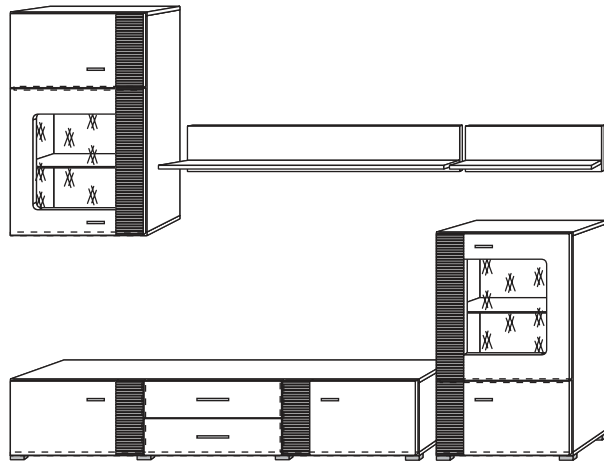

NO	Dim		Col.-No	Qty
1	954	330	16	1
2	954	330	16	1
5	568	310	16	1
12	567	295	6	1
3	602	330	16	1
4	602	330	16	1
6	965	579	3	1
9	596	326	16	1
7	596	652	16	1
11	422	366	4	1

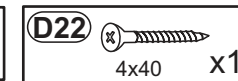
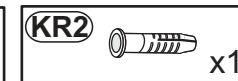
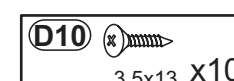
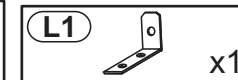
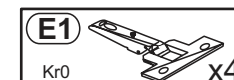
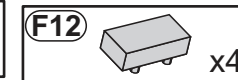
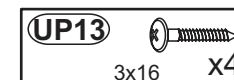
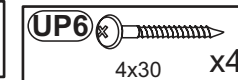
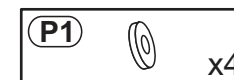
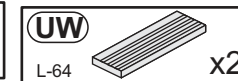
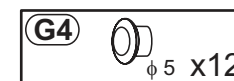
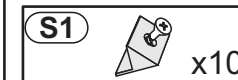
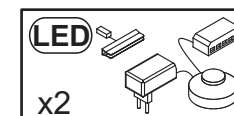
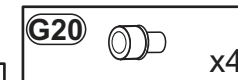
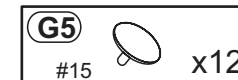
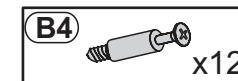
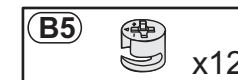
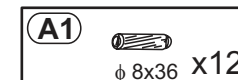
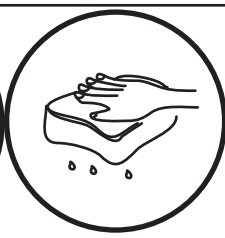
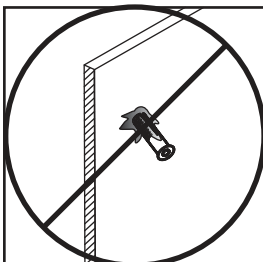
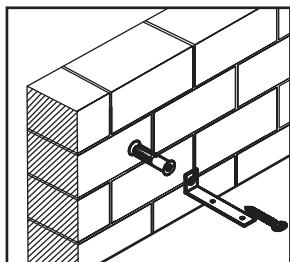
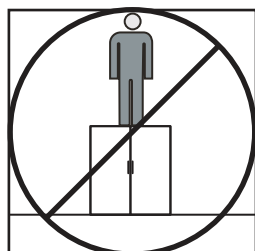
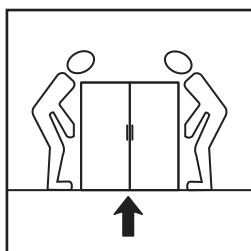
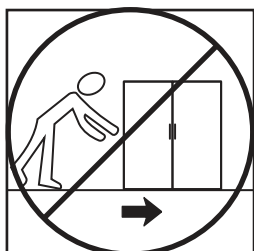
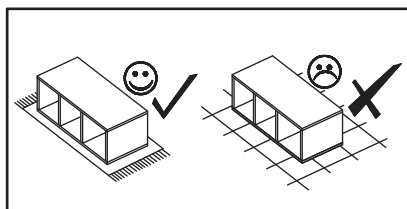
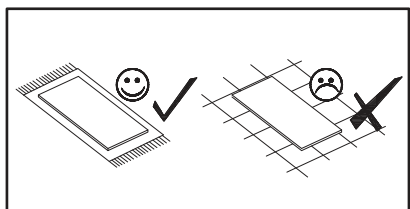
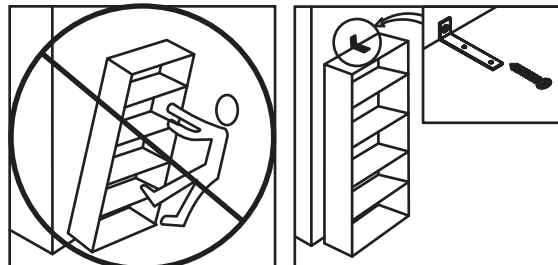
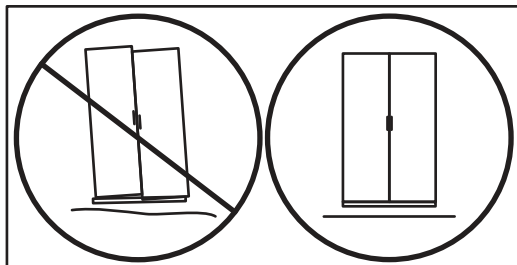
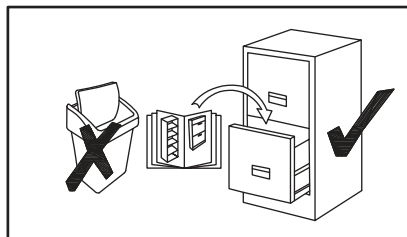
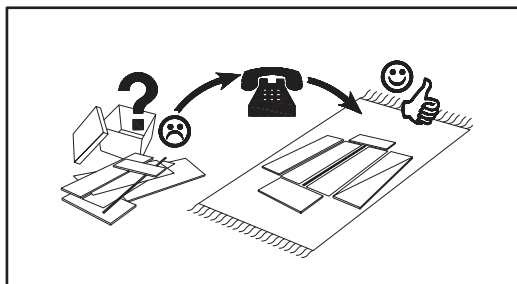

# 1

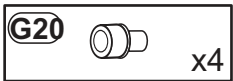
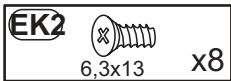
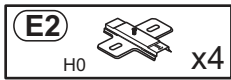
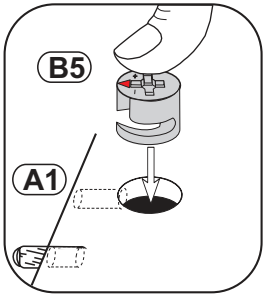
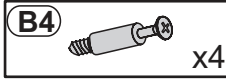
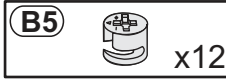
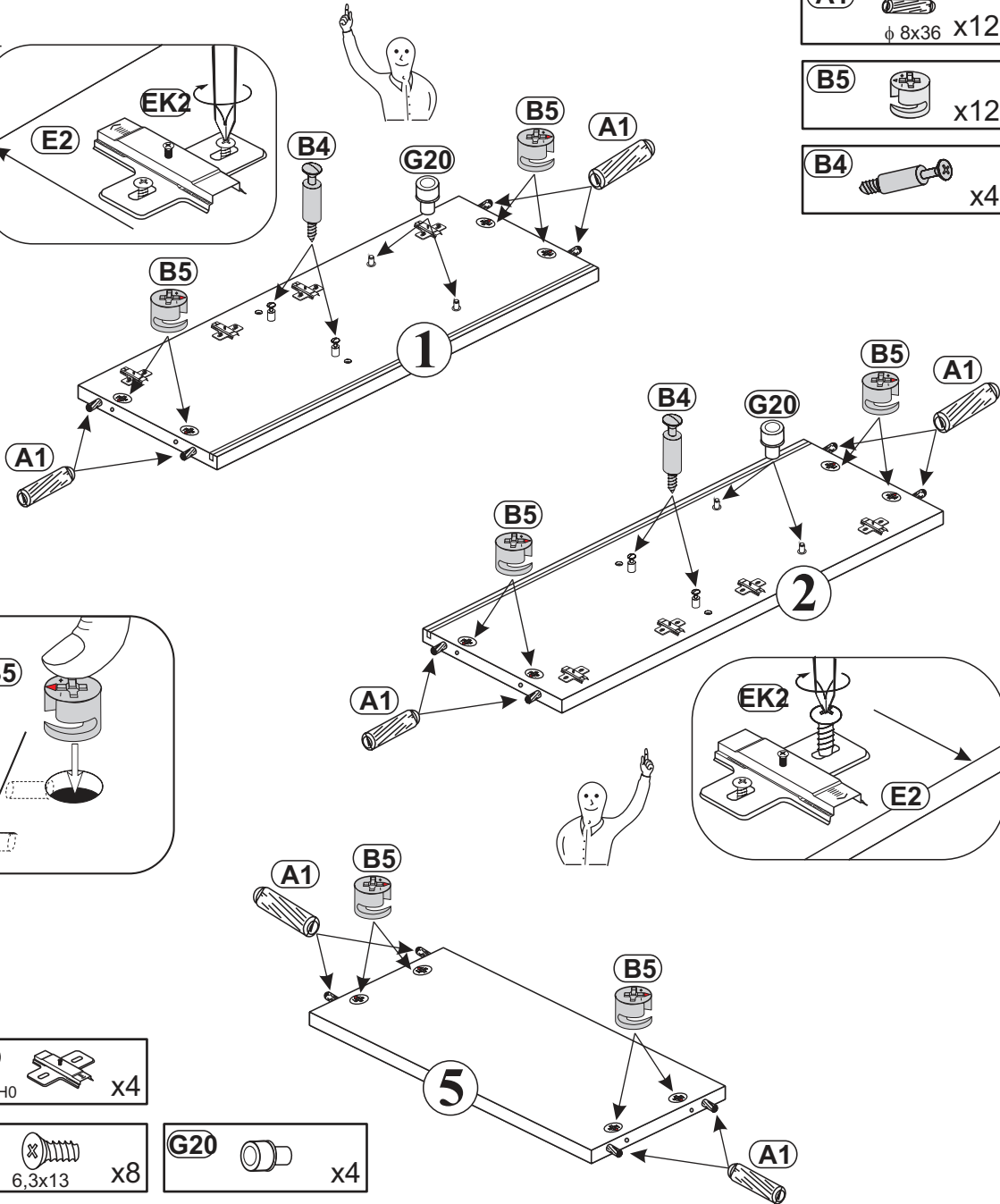
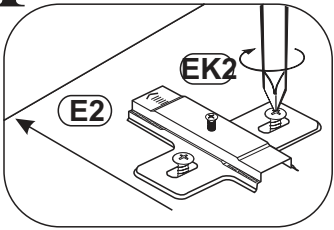

# 2

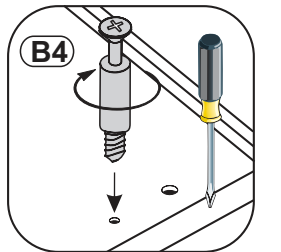
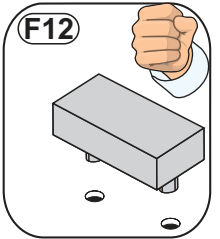
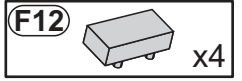
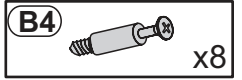
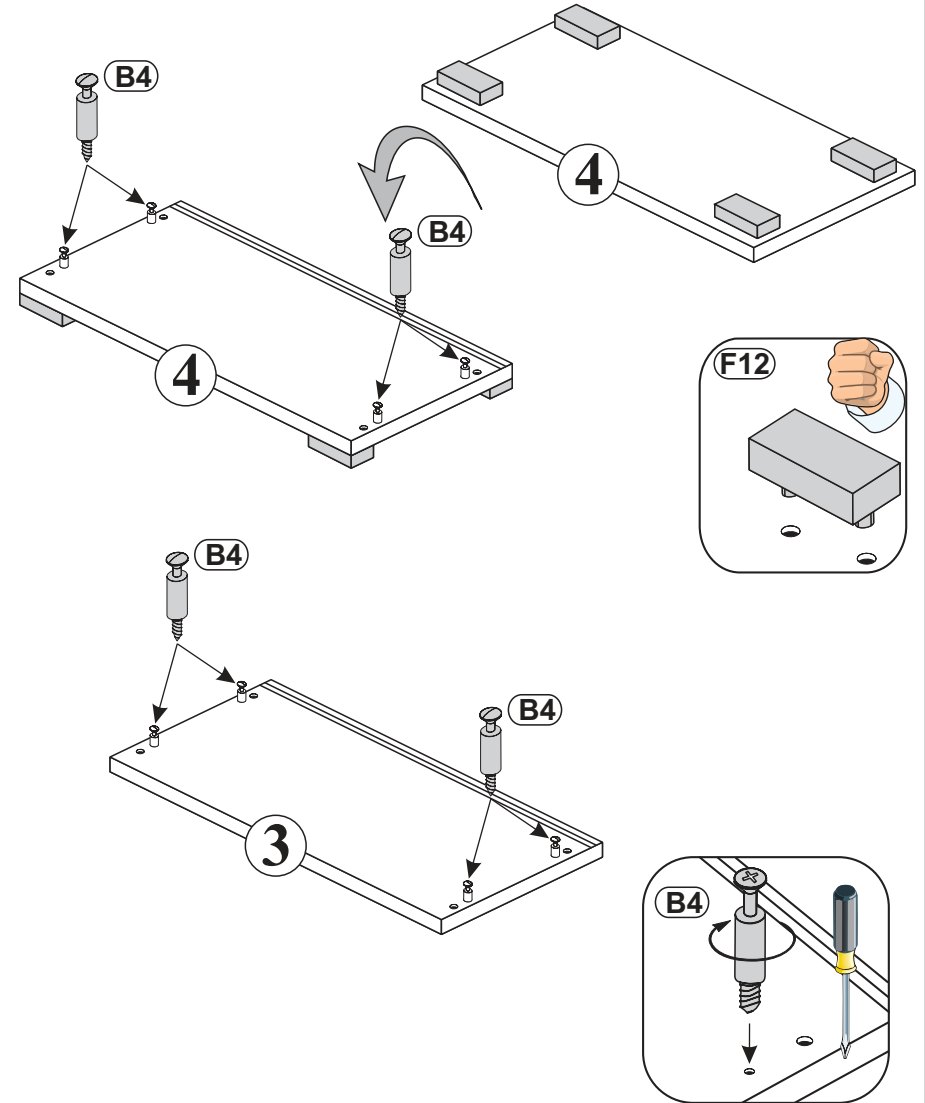

### 3

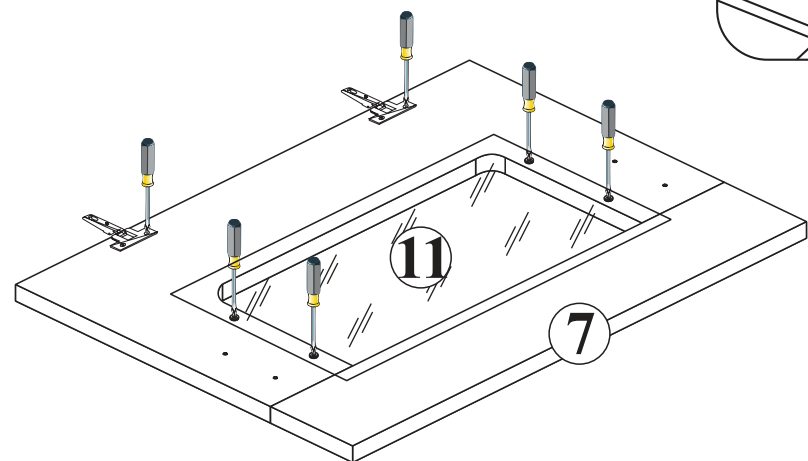
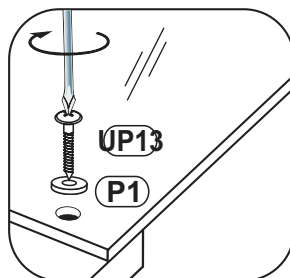
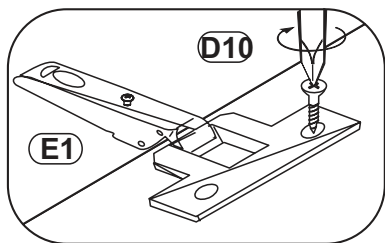
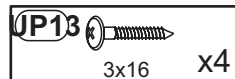
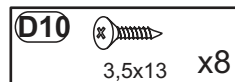
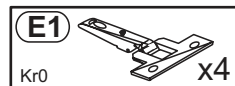
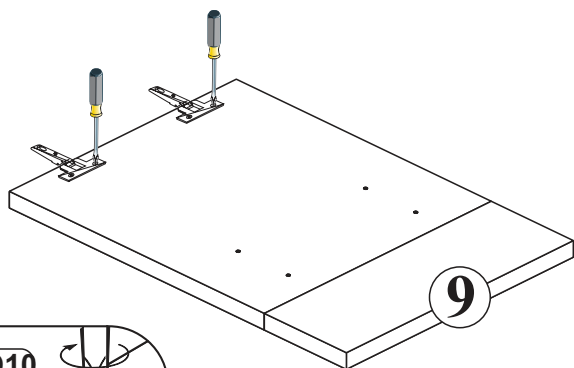

### 4

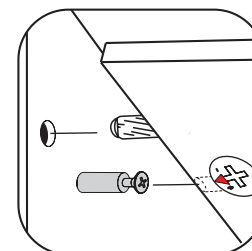
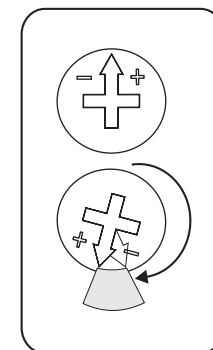
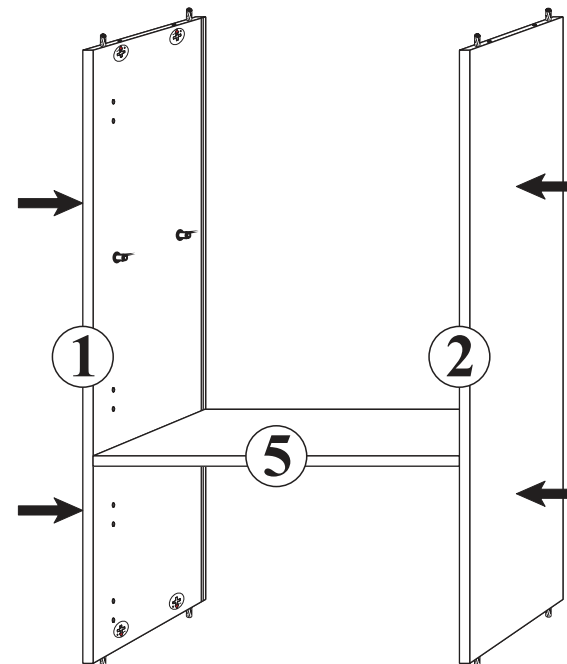

5

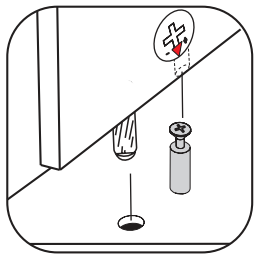
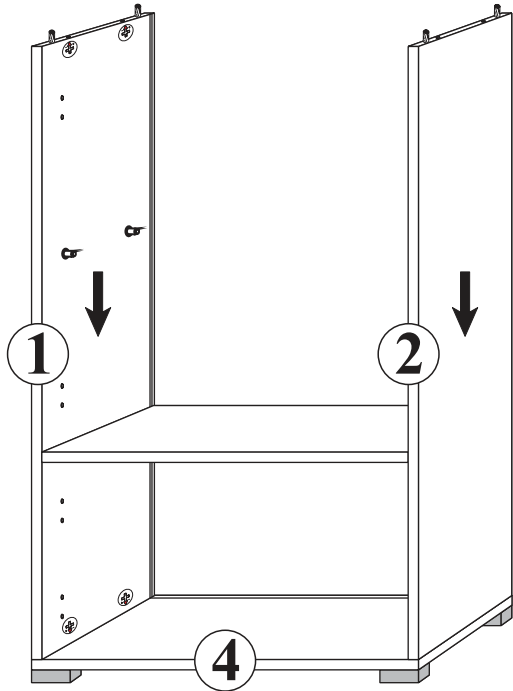

6

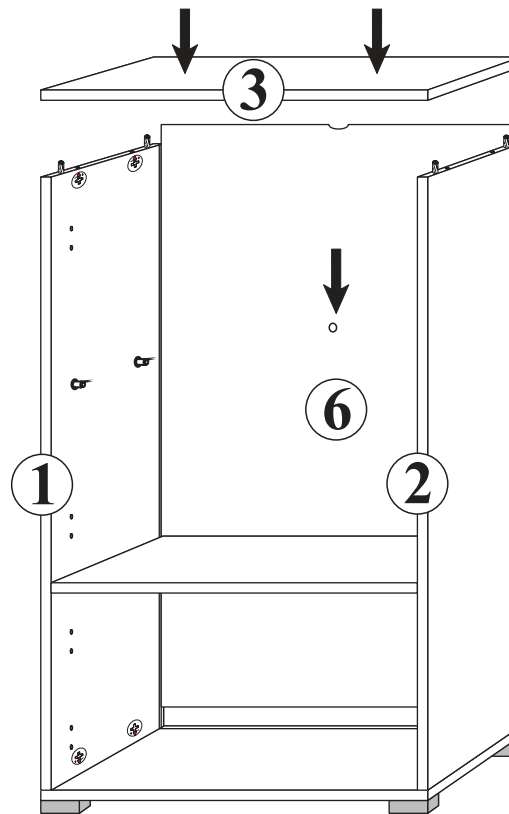
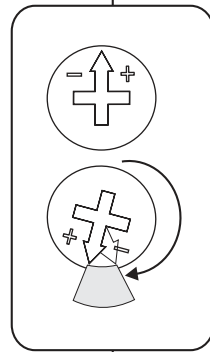
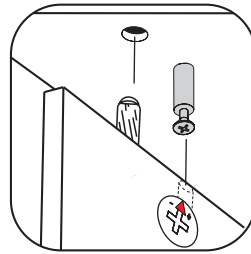

7



a=b

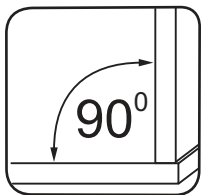
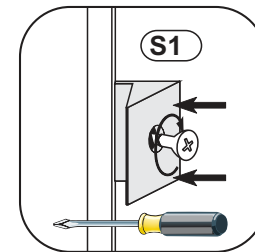
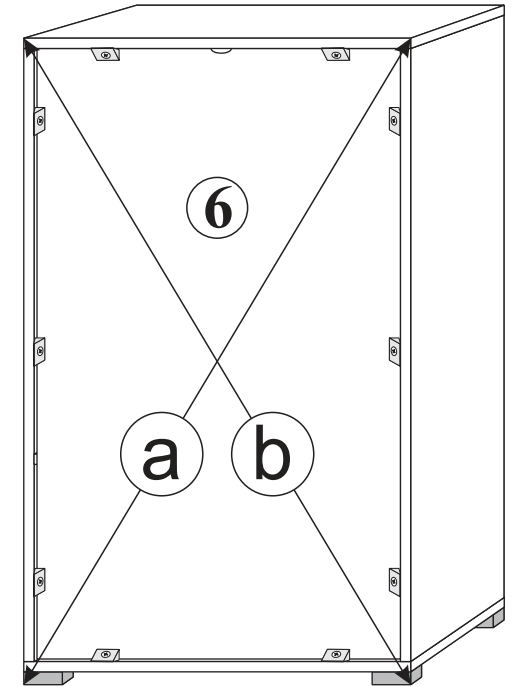





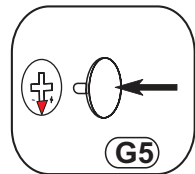
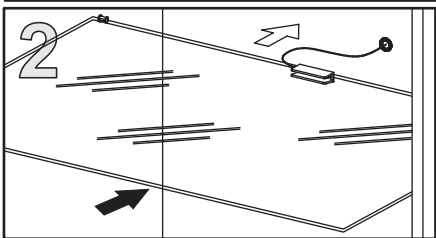
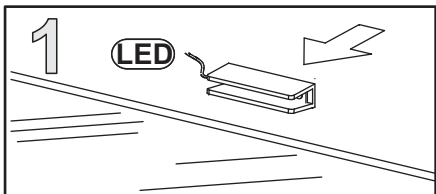
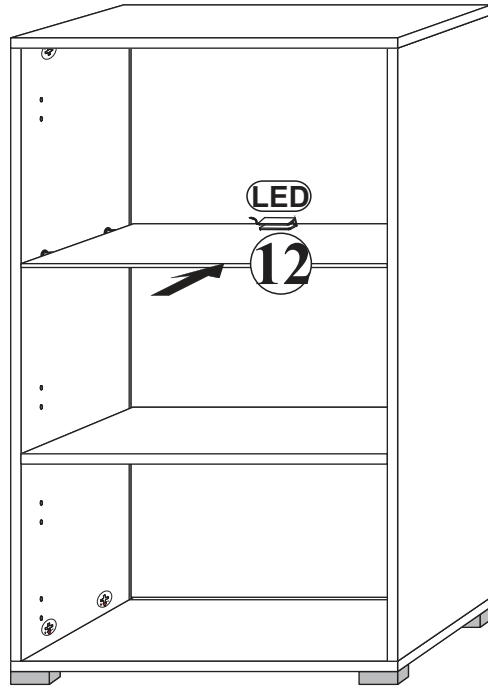
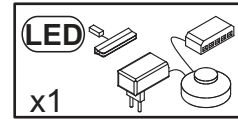

## 8

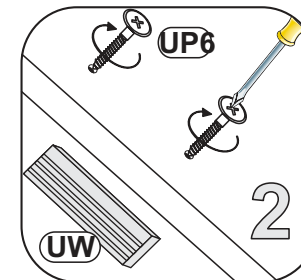
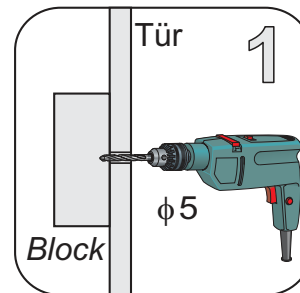
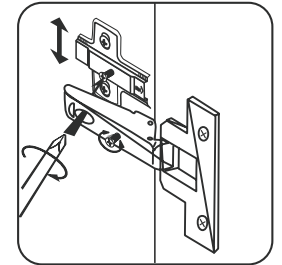
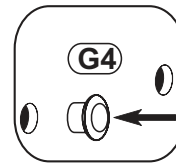
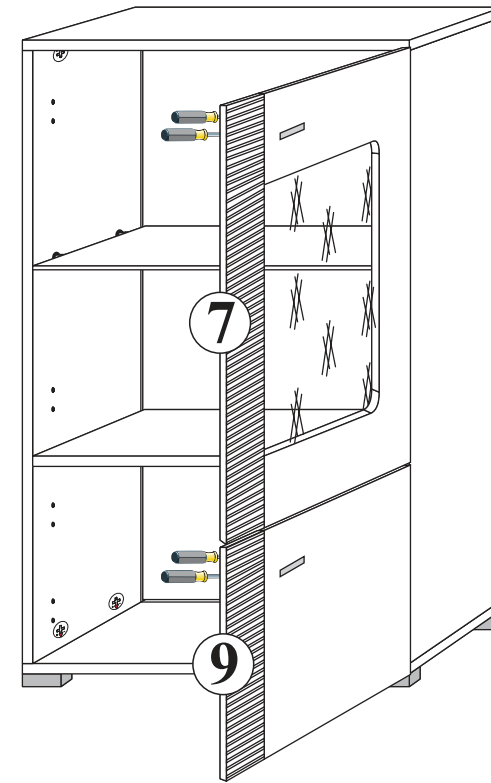
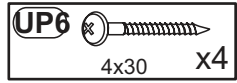
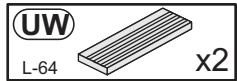
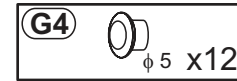

## 9

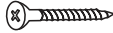

## 10

- D10**  3,5x13 x2
- L1**  x1
- KR2**  x1
- D22**  4x40 x1

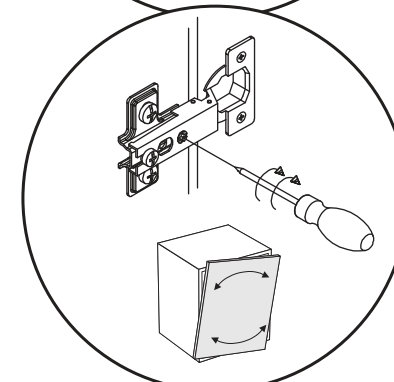
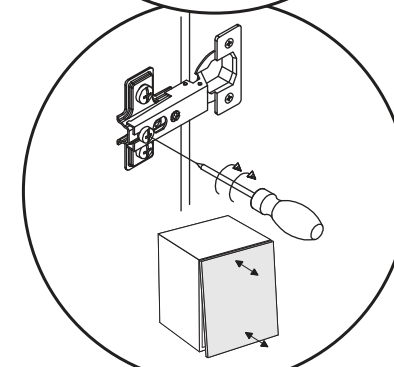
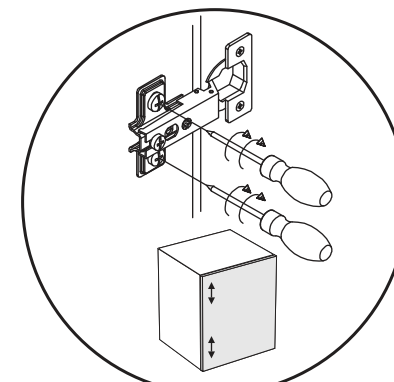
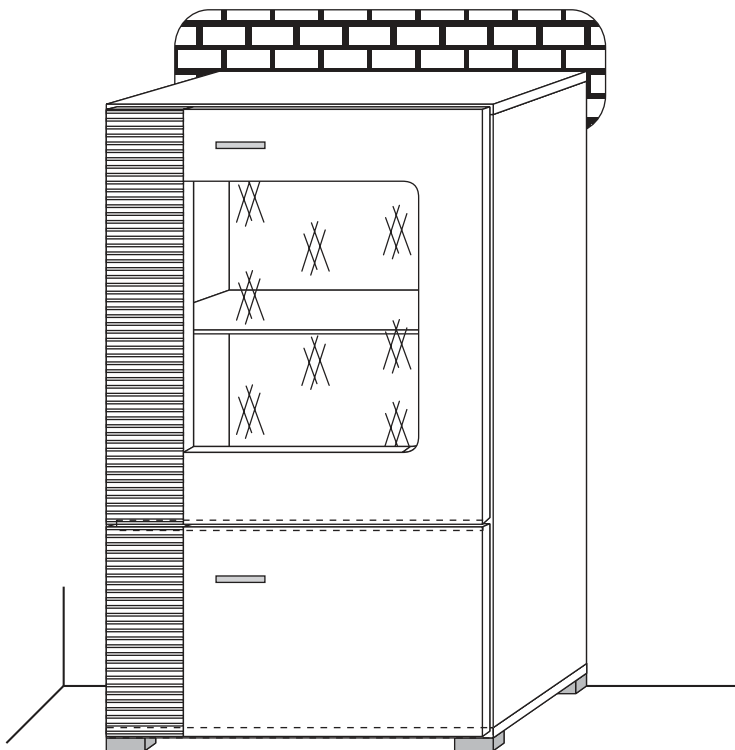
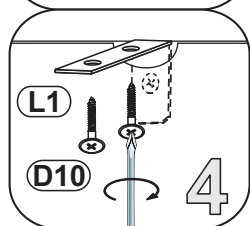
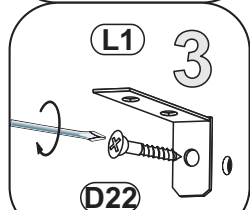
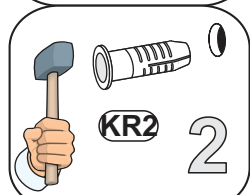
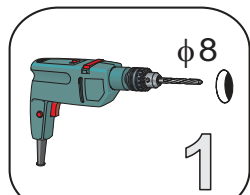

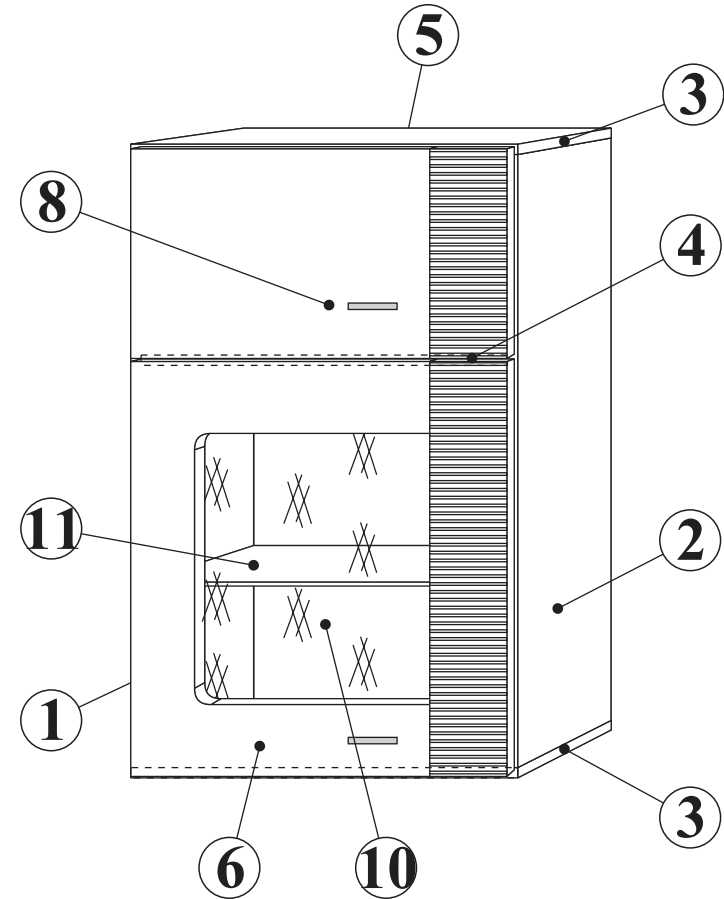
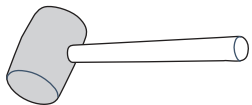
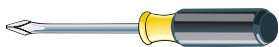
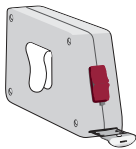
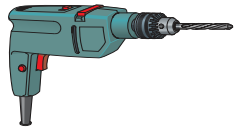
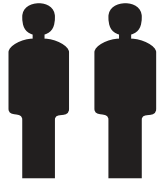
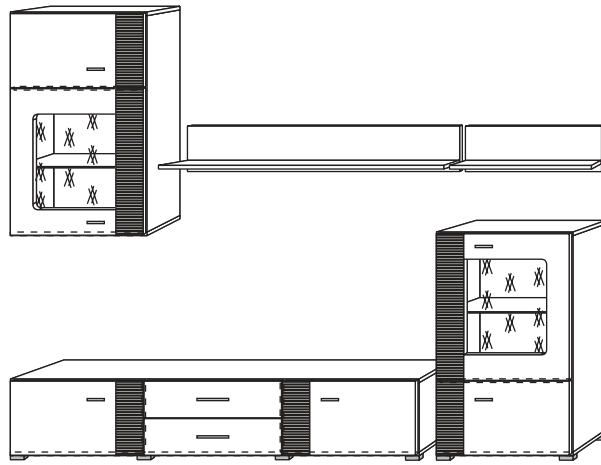

NO	Dim		Col.-No	Qty
1	954	330	16	1
2	954	330	16	1
4	568	310	16	1
11	567	295	6	1
3	602	330	16	2
5	965	579	3	1
8	596	326	16	1
6	596	652	16	1
10	422	366	4	1

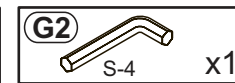
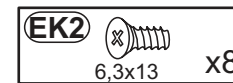
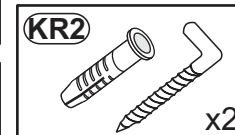
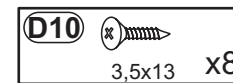
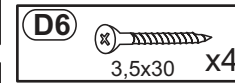
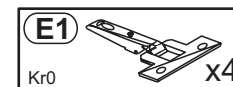
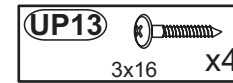
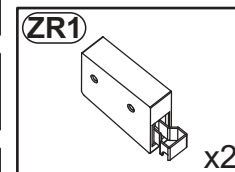
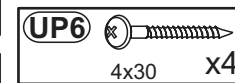
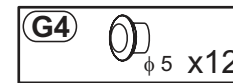
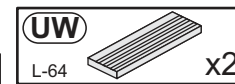
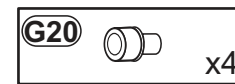
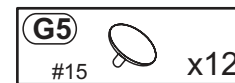
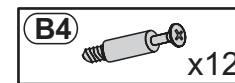
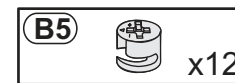
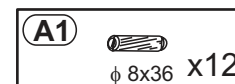
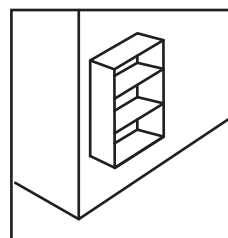
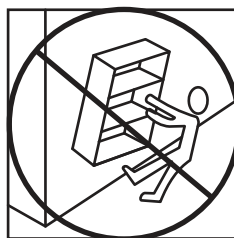
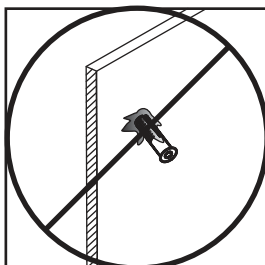
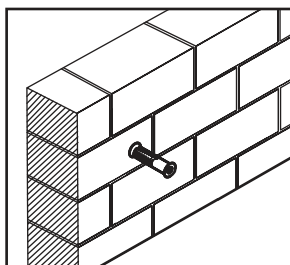
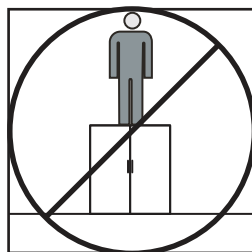
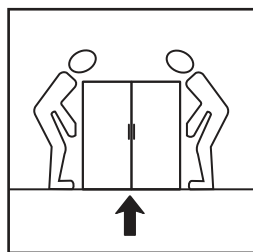
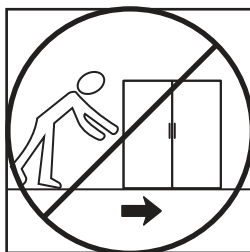
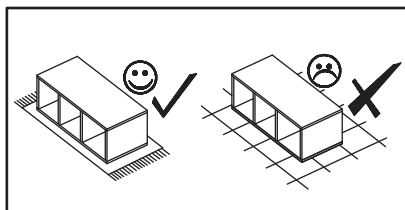
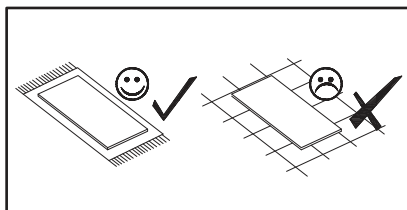
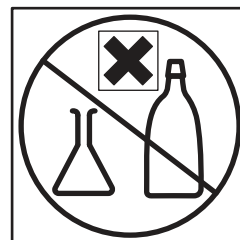
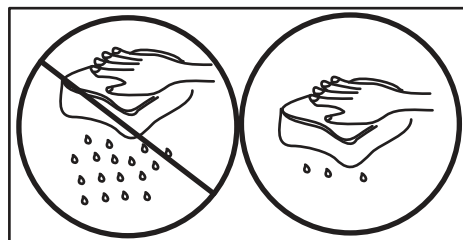
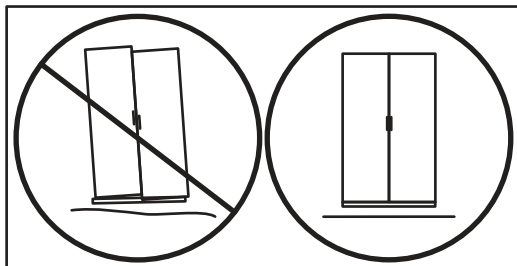
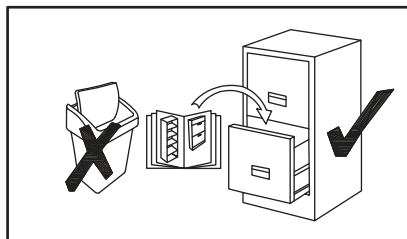
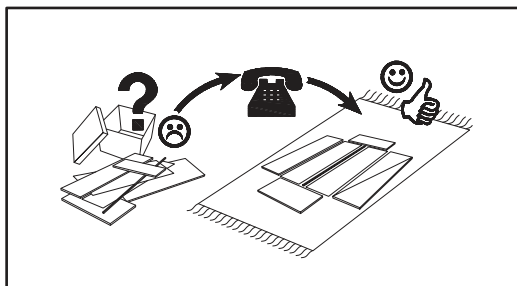

# 1

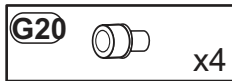
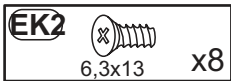
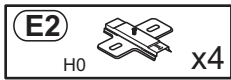
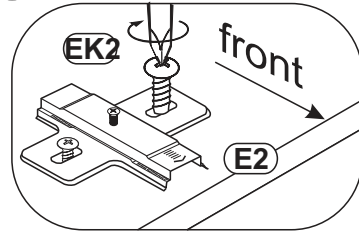
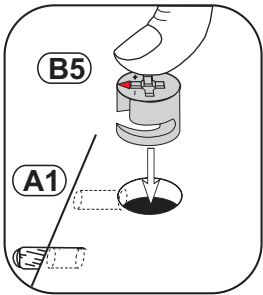
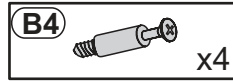
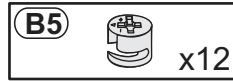
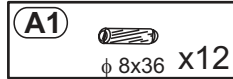
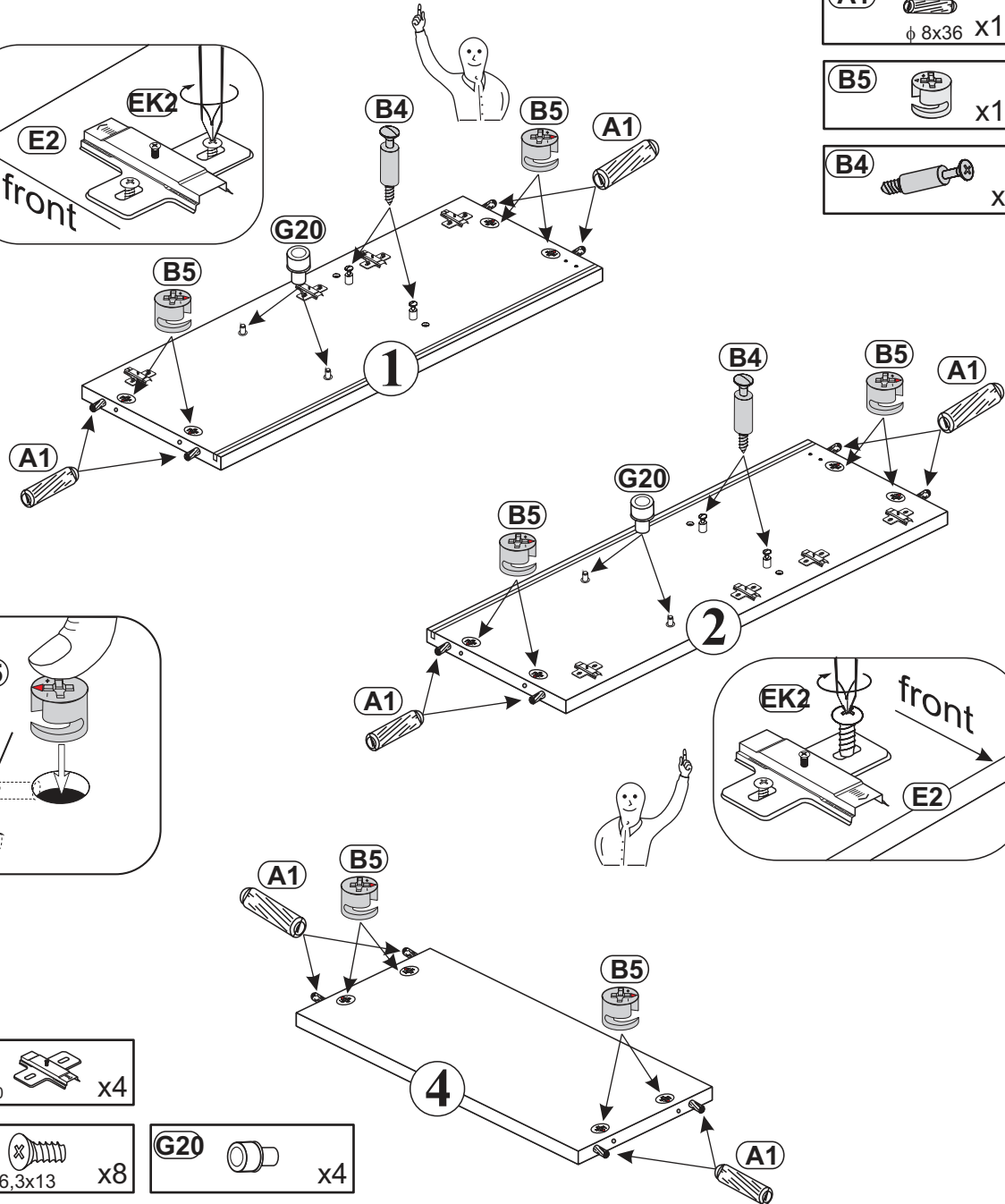
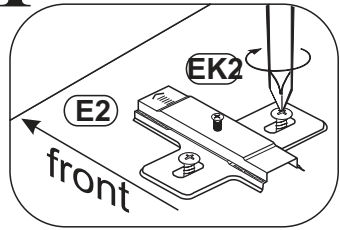

# 2

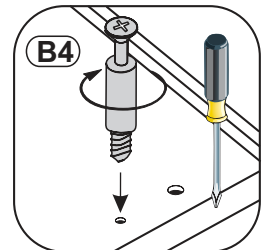
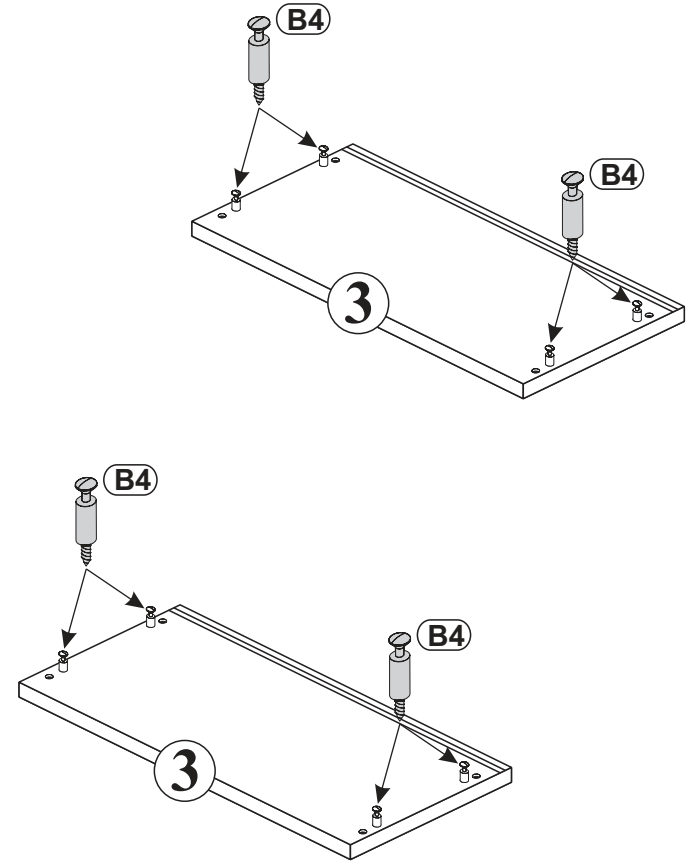
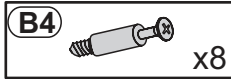

3

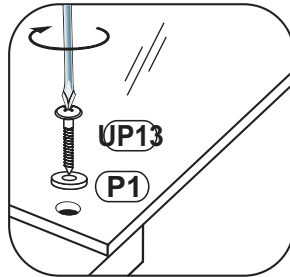
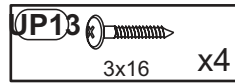
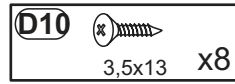
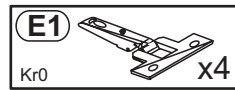
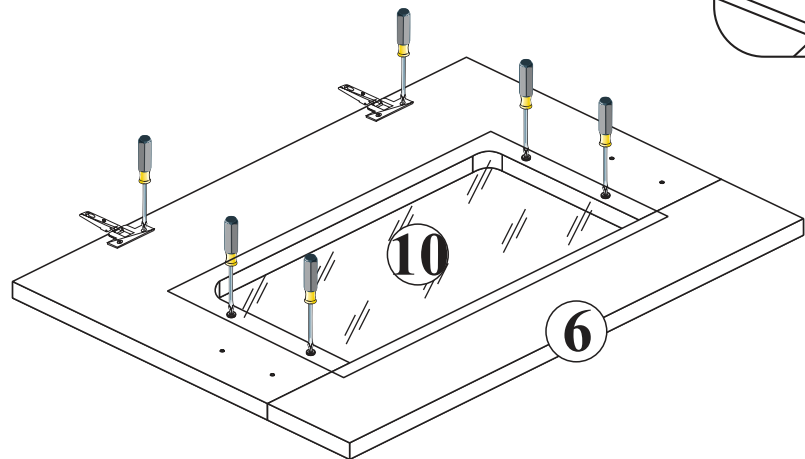
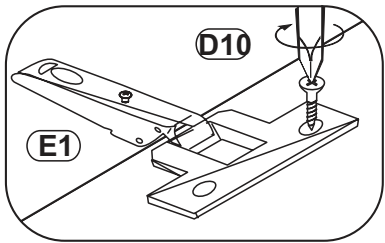
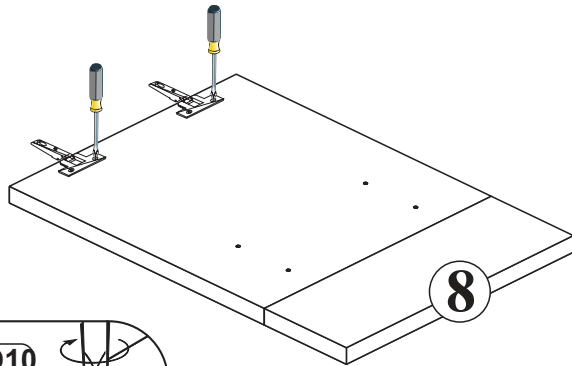

4

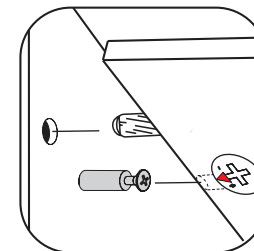
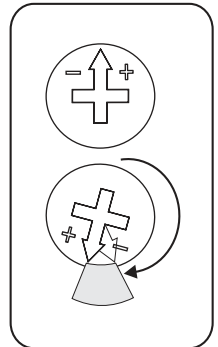
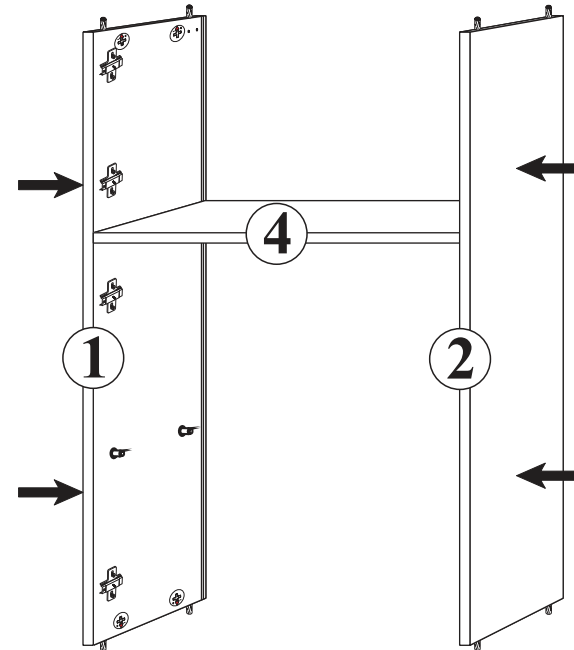

## 5

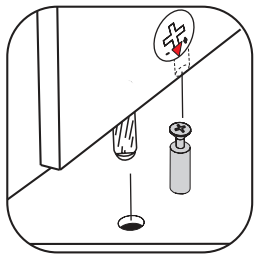
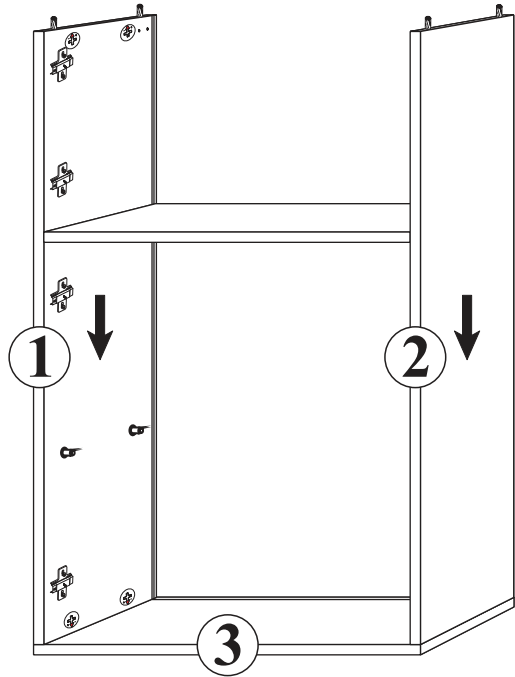

## 6

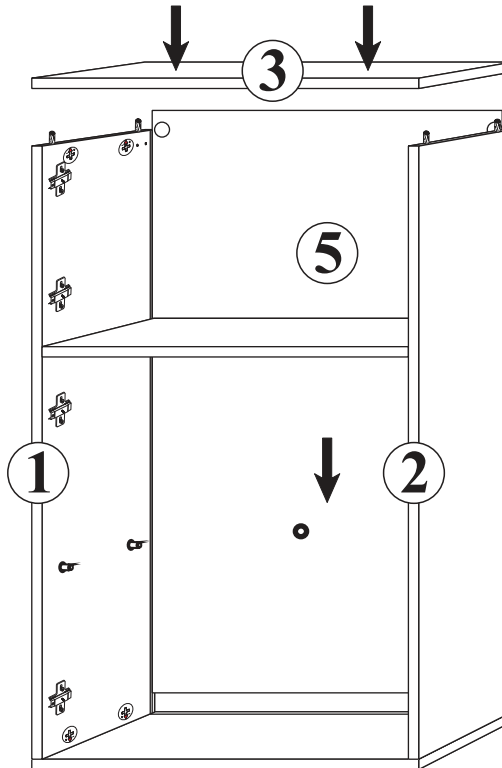
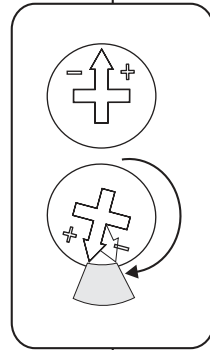
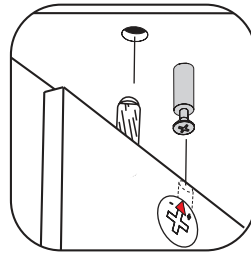

## 7



a=b

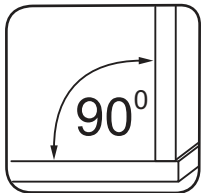
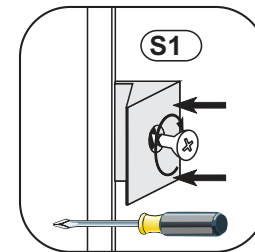
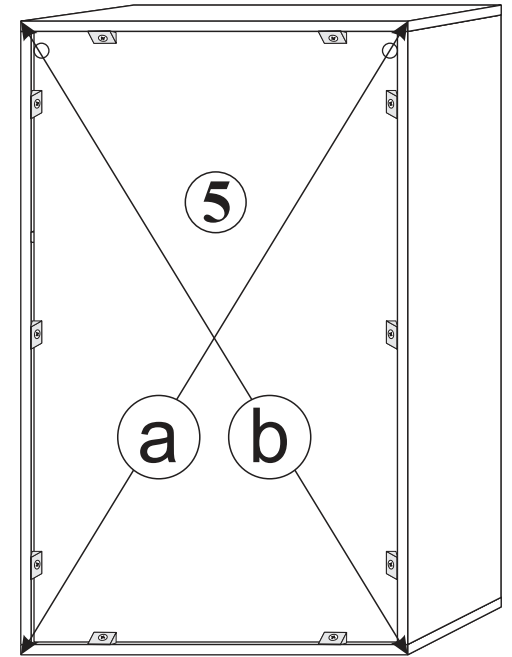

## 8

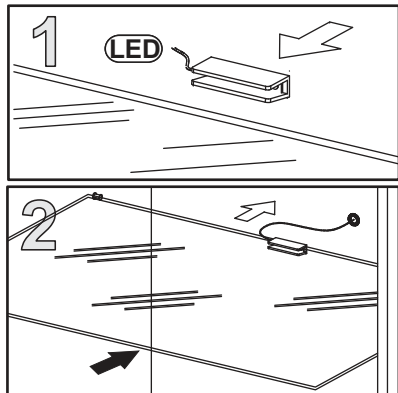
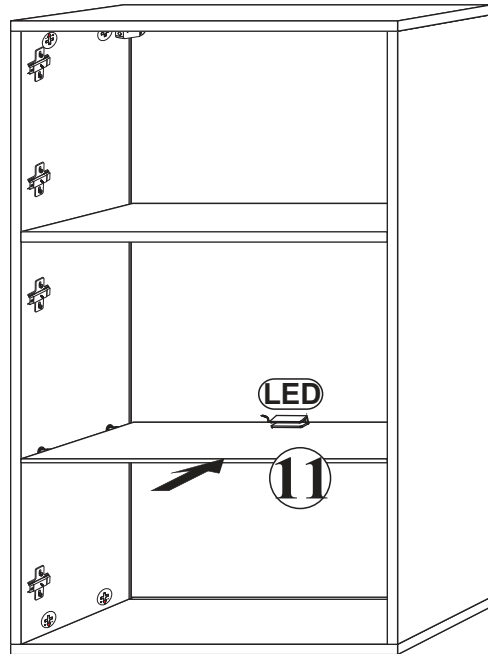
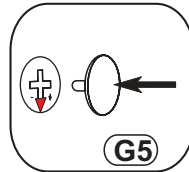
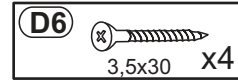
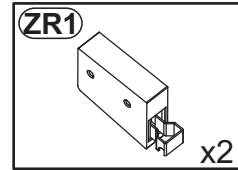
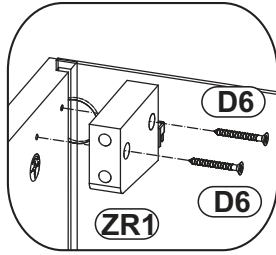

OŚWIETLENIE ZNAJDUJE SIĘ  
W PACZCE SZAFKI  
TYP 40

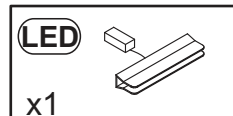

## 9

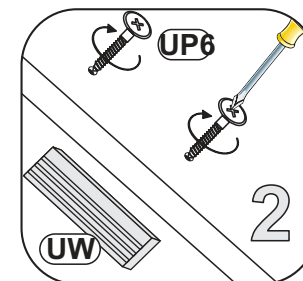
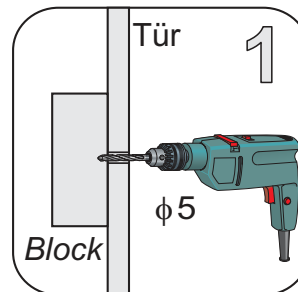
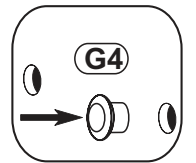
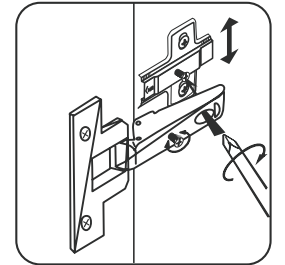
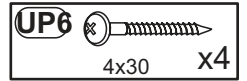
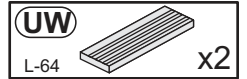
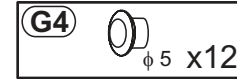
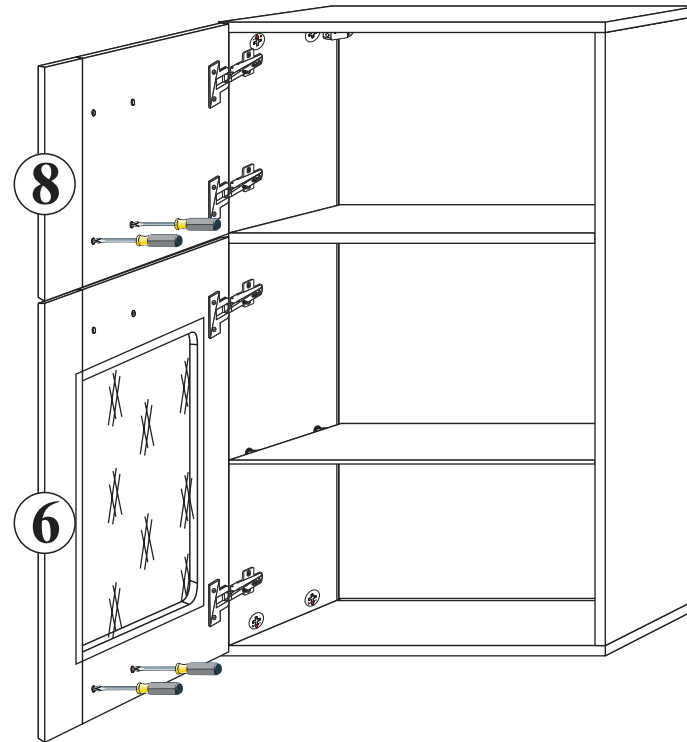



# 10

